

feeney®



Architectural & Garden Products

CableRail • DesignRail® • Rods • Trellises

Feeney® makes it easy

Since 1948, Feeney has pioneered industry-leading railing systems and other architectural and rigging products. If you want the highest quality architectural solutions supported by a friendly and easy process, you've come to the right place.

Feeney makes it easy!

Be sure to look for the official Feeney Authorized Dealer logo on the dealer website or in-store display to ensure that you are buying authentic Feeney products.



For questions or assistance locating a Feeney dealer near you, please give us a call at 1-800-888-2418 or visit www.feeneyinc.com for complete product information.

Also see us on:





Decks by Kiefer

CableRail

A wide selection of both kits and custom stainless steel cable assemblies for use as infill on railings, fences, and trellises.

PAGE

5

CableRail Kits
CableRail Custom Assemblies

6
18



Nat Rea Photography

DesignRail®

Powder-coated aluminum railings available in a variety of colors and top rail styles with glass, picket, and CableRail infill options.

PAGE

40



Architectural Rods

Stainless steel rods, components, and assemblies for use in structural and decorative applications.

PAGE

52



Trellises

Wall mounted and freestanding trellises with powder-coated aluminum support frames and stainless steel cable and rod vine lattices.

PAGE

58

Minimizing Environmental Impact

Feeney, Inc. fully supports the vision of developing and promoting environmentally responsible products and building practices in order to protect and manage our resources for future generations. Making this vision a reality is critical to the preservation of our resources, strength of our economy, and future of the world, and we all must get involved and do our part.

Our on-going commitment to minimizing environmental impact includes making products that last using mostly recycled materials and generating solar power at our California headquarters to offset over 95% of the facility's electrical usage.



To discuss how our products can help you earn LEED® credits for your upcoming projects, please give us a call at 1-800-888-2418.

CABLE·RAIL®

Stainless Steel Cable Assemblies that Enhance Any Railing and Any View!

CableRail is the perfect railing infill alternative to pickets and glass panels. It's made from beautiful and weather-tough 316-grade stainless steel with an assortment of cable and attachment hardware options. CableRail is strong, durable, easy to install, low maintenance, and virtually invisible. Easy on both the eyes and the view, it's an ideal complement to any railing design, indoors or out, and with a recycled material content over 70%, it's easy on the environment as well.

Our CableRail product line features the following two categories:

1

CableRail Kits (page 6)

- Sold in pre-cut standardized lengths that can be quickly trimmed to size in the field
- Includes special Quick-Connect® Inset fittings for fast, easy installation
- Available in 3 cable diameters, with special low-profile components that make measuring, ordering, and installing a breeze

2

Custom Cable Assemblies (page 18)

- For projects with special installation conditions or design aesthetics
- Available in a wide assortment of cable and fitting options
- Sold as assemblies, ready to install, or as individual components that can be assembled in the field



Continuing Education Course:

Cable Railing Assemblies: Prefabricated Kits & Custom Design Options is available online for free.

You can learn all about cable railings while earning continuing education units (CEU) and Health, Safety, and Welfare (HSW) credits.

For information and links, please visit our website: **www.feeneyinc.com**



CABLE·RAIL[®] Kits

Standardized Kits Make Measuring, Ordering, and Installing a Breeze.

CableRail Kits are sold in a wide range of standardized pre-cut lengths for easy ordering. There is no wasted time taking precise railing measurements; just select assemblies that are longer than you need and trim any excess in the field. Each kit includes a special Threaded Terminal and automatic-locking Quick-Connect[®] Inset attachment fittings that are sleek, simple to use, and easy to conceal. The result is extremely durable and virtually invisible, allowing beautiful, unimpaired views.

- Made from high-strength, low-maintenance, weather-tough, 316-grade stainless steel
- Available in 1/8-in, 3/16-in, and 1/4-in diameter cable to complement any railing design
- Sold in a wide range of standard lengths (5-ft to 70-ft in 5-ft increments) that can be trimmed to a finished length in the field
- Automatic-locking Quick-Connect[®] Inset fittings make installation fast and easy
- May be installed on new or existing wood or metal railing frames in exterior, interior, residential, and commercial settings
- Complete installation instructions, frame requirements, 3-part specifications, and detail drawings are available at www.feeneyinc.com
- Toll-free information and assistance line, 1-800-888-2418
- Product contains recycled materials 

See our new CableRail Conceal Kits on page 16



Stainless Quick-Connect® Inset fittings make cable projects quicker and easier than ever

Each kit comes with a Threaded Terminal fitting pre-attached to one end of the cable and a field installed Quick-Connect® Inset fitting for the other end. Simply secure the Threaded Terminal to one end post, lace the free end of the cable through the remaining posts, slip on a Quick-Connect® Inset fitting, tension the line, trim the excess, and finish with decorative end caps.

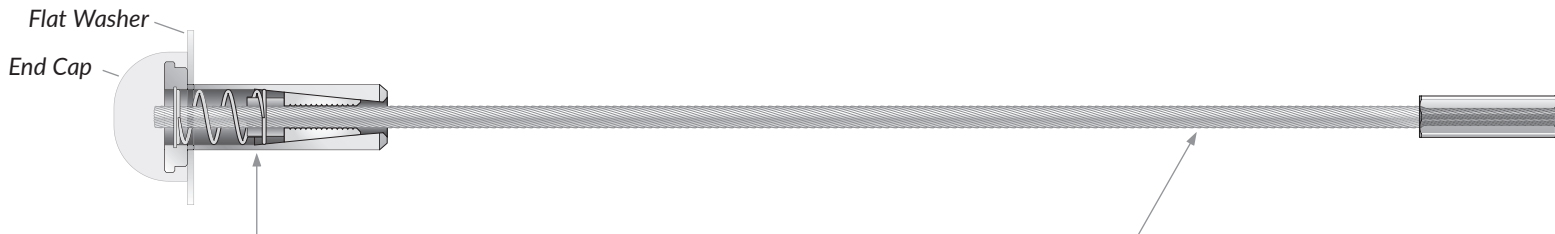

Our unique stainless steel Quick-Connect® Inset fitting is attached to the cable in the field without special tools. One-way jaws allow the cable to easily slide through the fitting in one direction and automatically grab and lock-on when the cable is released. Just slip it on, pull the cable tight, and cut the excess.



The cable is 1x19 construction, 316-grade stainless steel for strength, durability, and weather protection. Available in 1/8-in, 3/16-in, and 1/4-in diameters.

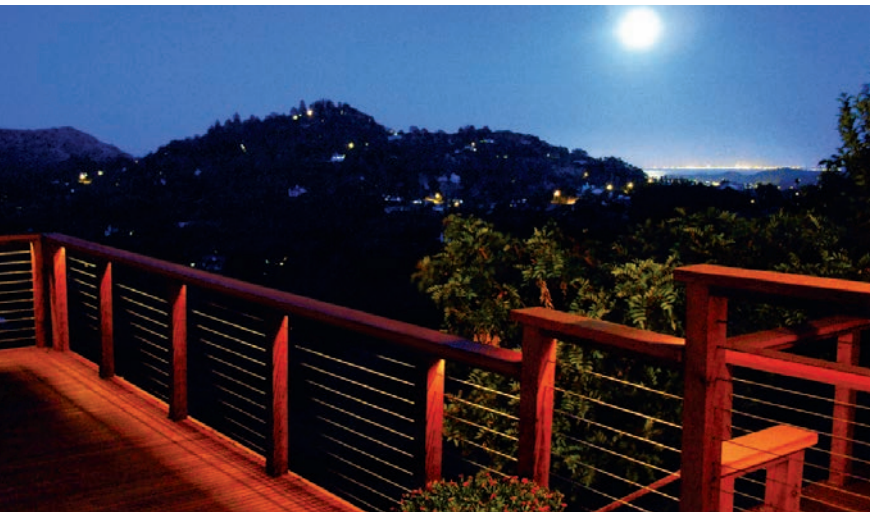

Components that are made to last. All of our cables and fittings are manufactured from high-quality 316-grade stainless steel for weather-tough durability, low maintenance, and lasting beauty.

The stainless Threaded Terminal fitting is fastened (swaged) to one end of the cable at the factory. It is then attached to an end post using our unique Snug-Grip® Washer Nut with special gripping threads to help prevent the nut from loosening. Spin the nut to adjust final tension in the line. Available in 7½-in length for wood posts and 4¼-in for metal posts.

Flat Washers and Snug-Grip® Washer Nuts are all included. Attach Colored or Stainless Steel End Caps to cover, protect, and finish both ends (Caps sold separately, page 11).

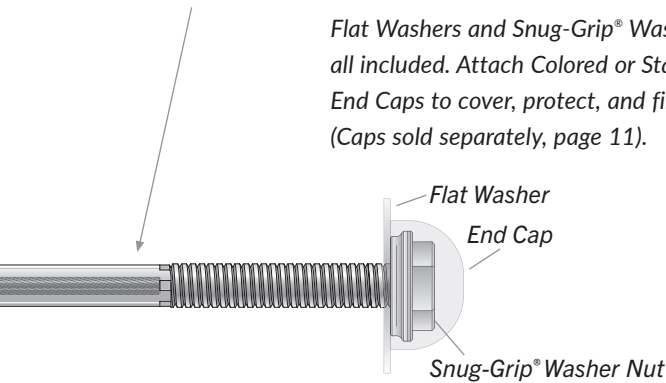

For oversized or irregular posts that require a custom thread length, use our All-Thread Receiver (ATR) Kits. The special receiver fitting accepts any length of ¼-in all-thread rod from 1-in to 36-in. (All-Thread #4802 sold separately by the inch). Each ATR Kit includes a pre-cut length of cable with an ATR fitting attached to one end, Quick-Connect® Inset fitting, Snug-Grip® Washer Nut and both stainless steel and nylon flat washers.



Our cables are designed to be used on your own wood or metal frames in either indoor or outdoor settings. However, we do offer a complete aluminum railing frame system. See details in the DesignRail® Aluminum Railings section (page 40) or visit www.feeneyinc.com



Boardman Construction

CableRail Kit Options

Assembly Lengths

With 4-1/4-in Terminal for Metal Posts

With 7-1/2-in Terminal for Wood Posts

**With All-Thread Receiver Fittings for Wood or Metal Posts

1/8-in Kits

- Our most popular and cost effective cable option
- Perfect for all residential and light commercial projects
- Can be installed on wood or metal frames

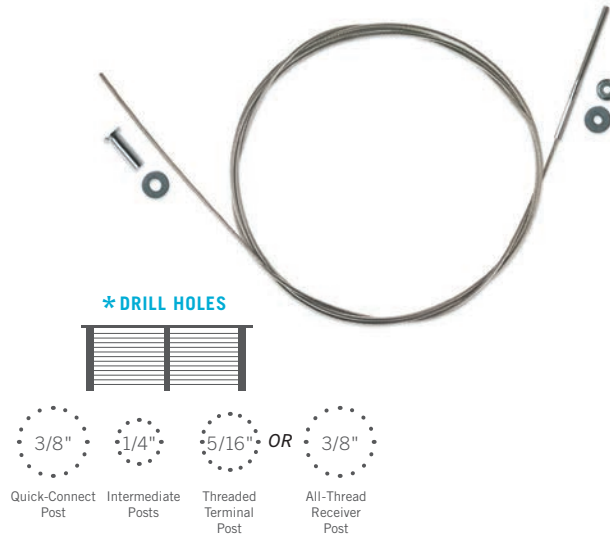

1/8-in

5'	6205	6305	2005
10'	6210	6310	2010
15'	6215	6315	2015
20'	6220	6320	2020
25'	6225	6325	2025
30'	6230	6330	2030
35'	6235	6335	2035
40'	6240	6340	2040
45'	6245	6345	2045
50'	6250	6350	2050
55'	6255	6355	2055
60'	6260	6360	2060
65'	6265	6365	2065
70'	6270	6370	2070

3/16-in Kits

- Extra durable option for commercial and residential settings
- Can be installed on wood or metal railing frames

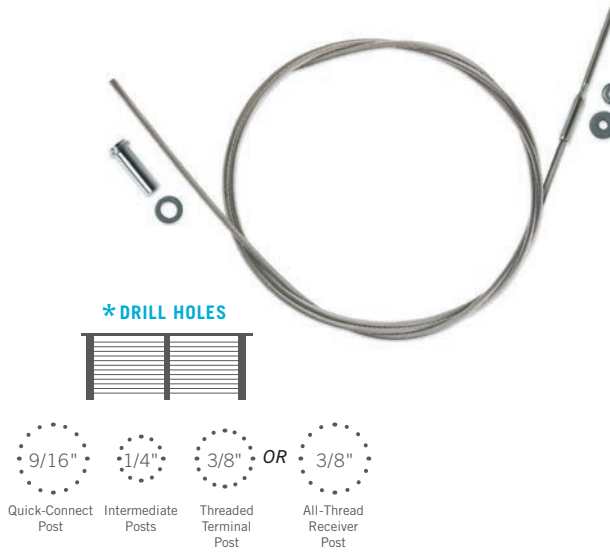

3/16-in

5'	6705	6805	4005
10'	6710	6810	4010
15'	6715	6815	4015
20'	6720	6820	4020
25'	6725	6825	4025
30'	6730	6830	4030
35'	6735	6835	4035
40'	6740	6840	4040
45'	6745	6845	4045
50'	6750	6850	4050
55'	6755	6855	4055
60'	6760	6860	4060
65'	6765	6865	4065
70'	6770	6870	4070

1/4-in Kits

- Largest, most durable option for high-traffic, high-wear commercial locations
- Also for railing designs where the "look" of a larger cable is desired
- Recommended for metal railing frames only

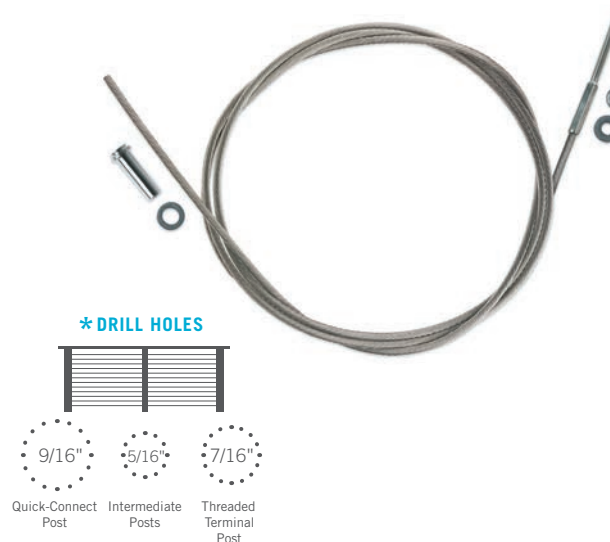

1/4-in

5'	6905	Not recommended for wood posts
10'	6910	
15'	6915	
20'	6920	
25'	6925	
30'	6930	
35'	6935	
40'	6940	
45'	6945	
50'	6950	
55'	6955	
60'	6960	
65'	6965	
70'	6970	

* Note: Drill hole sizes may differ if using Isolation Bushings (pg.12). Call to confirm correct drill sizes.

** (#4802) 1/4-in. All-Thread rod for All-Thread Receiver Kits sold separately. (pg.11)

Decorative End Caps snap on to the exposed Quick-Connect® Inset fittings and Snug-Grip® Washer Nuts to cover, protect, and finish both ends (caps sold separately).



COLORED END CAPS
(Polyethylene)

Part#	Color	Size
7071	Black	3/4"OD x 7/16"H
7072	White	3/4"OD x 7/16"H
7073	Brown	3/4"OD x 7/16"H
7074	Gray	3/4"OD x 7/16"H
7075	Silver	3/4"OD x 7/16"H
7076	Taupe	3/4"OD x 7/16"H
7077	Bronze	3/4"OD x 7/16"H
7078	Green	3/4"OD x 7/16"H
7079	Cream	3/4"OD x 7/16"H

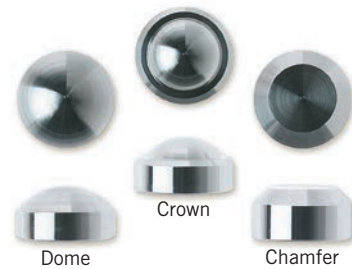

STAINLESS END CAPS (316-Stainless)

Part#	Style	Size
3372	Dome	3/4"OD x 3/8"H
3373	Crown	3/4"OD x 3/8"H
3374	Chamfer	3/4"OD x 3/8"H



ALL-THREAD ROD (316-Stainless)

- Use with 1/8-in and 3/16-in All-Thread Receiver (ATR) Kits
- Available from 1-in to 36-in, in 1-in increments

Part#	Description
4802	1/4-20, right hand



Extra Parts & Tools



RUBBER GROMMETS

- (Optional) For adding a finished detail to holes in tubular metal intermediate posts
- Use with 1/8-in diameter cable only
- Fits 1/4-in diameter drill holes

Part#	Size
3213	1/4"OD x 3/16" groove, 7/16" flange



ISOLATION BUSHINGS

- For eliminating direct contact of dissimilar metals to minimize electrolysis when attaching cables and fittings to metal posts in areas with salt air or similar harsh elements
- Engineered polymer that's highly resistant to abrasion and UV degradation
- Wide operating temperature range, -40°F to +266°F
- Must use silicone sealant (not included) to secure bushings in posts

Part#	Used On	Size	HoleØ
1100	1/8" Quick-Connect® Inset	3/8"ID x 15/32"OD, 11/16" flange	15/32"
1101	1/8" Cable	3/16"ID x 1/4"OD, 3/8" flange	1/4"
1102	1/8" Threaded Terminal	1/4"ID x 5/16"OD, 1/2" flange	5/16"
1103	3/16" Quick-Connect® Inset	35/64"ID x 5/8"OD, 55/64" flange	5/8"
1102	3/16" Cable	1/4"ID x 5/16"OD, 1/2" flange	5/16"
1100	3/16" Threaded Terminal	3/8"ID x 15/32"OD, 11/16" flange	15/32"
1103	1/4" Quick-Connect® Inset	35/64"ID x 5/8"OD, 55/64" flange	5/8"
1104	1/4" Cable	9/32"ID x 23/64"OD, 19/32" flange	23/64"
1105	1/4" Threaded Terminal	7/16"ID x 17/32"OD, 3/4" flange	17/32"

Note: HoleØ is the required post hole size after any galvanized, paint, or powder coatings are applied to the metal frame. Metal frames are all different, so please call to confirm correct bushing sizes and corresponding hole diameters for your frame condition. Also see the Accessories section on our website www.feeneyinc.com



STAINLESS BEVELED WASHERS (316-Stainless)

- For providing a flat bearing surface when attaching fittings at angled stair terminations
- 3 angle options to fit most stairs conditions

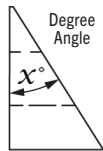

x°	x°	x°	Fitting Used	Size
26°-Part#	32°-Part#	37°-Part#		
3794	3792	3797	1/8" Quick-Connect® Inset	3/8"ID x 3/4"OD
3790	3799	3796	1/8" Threaded Terminal	9/32"ID x 3/4"OD
3795	3798	3787	3/16" Quick-Connect® Inset	9/16"ID x 3/4"OD
3790	3799	3796	3/16" Threaded Terminal	9/32"ID x 3/4"OD
3795	3798	3787	1/4" Quick-Connect® Inset	9/16"ID x 3/4"OD
3794	3792	3797	1/4" Threaded Terminal	3/8"ID x 3/4"OD

STAINLESS PROTECTOR SLEEVES (316-Stainless)

- (Wood posts only) For protecting corner and stair transition posts from cable abrasion
- Use with 1/8-in and 3/16-in diameter cables
- Fits 1/4-in diameter drill holes



Part#	Size
3210	1/4"OD x 7/8" L, 1/2" flange

FEENEY ALUMINUM INTERMEDIATE PICKETS

- (Wood frames only) slender, low-maintenance, time-saving vertical spacer option for maintaining cable spacing
- Pre-drilled for 1/8-in cables at 3-in spacing
- Slotted holes in stair pickets accommodate 20-45 degree slope
- Field trimmed to fit railings up to 42-in high
- Powder coated finish, available in Silver, Black, & White
- Includes base plates and screws

Part#	Description
7648 SLV-PKG	Level rail picket, 3/4" sq x 44" long; Silver
7649 SLV-PKG	Stair rail picket, 3/4" sq x 46" long; Silver
7648 BLK-PKG	Level rail picket, 3/4" sq x 44" long; Black
7649 BLK-PKG	Stair rail picket, 3/4" sq x 46" long; Black
7648 WHT-PKG	Level rail picket, 3/4" sq x 44" long; White
7649 WHT-PKG	Stair rail picket, 3/4" sq x 46" long; White

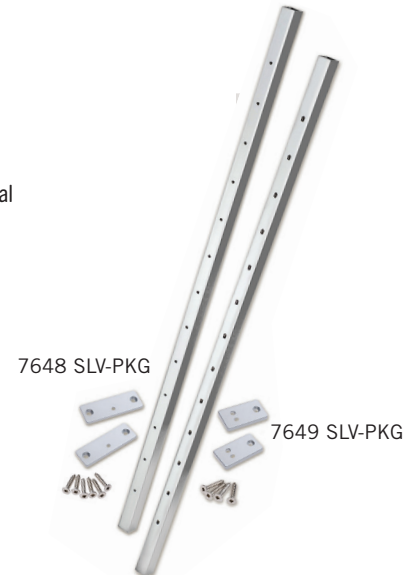

CABLE CUTTERS

- For shearing excess cable

Part#	Cable	Length
2972-PKG	up to 1/8"	7-1/2"
2971	up to 1/4"	13"

- ▲ **WARNING:** These cutters can expose you to Di(2-ethylhexyl)phthalate (DEHP) which has been determined by the State of California to cause cancer and birth defects or other reproductive harm. For more information go to www.P65Warnings.ca.gov

QUICK-CONNECT® RELEASE TOOLS

- For disengaging and removing or readjusting the Quick-Connect® Inset fittings

Part#	Description
3128	for 1/8" Quick-Connect®, reusable
3158	for 3/16" Quick-Connect®, reusable

CABLE LACING NEEDLES

- For quickly lacing cable ends through posts without snagging

Part#	Cable Size	Length
3221	1/8"	4-1/2"
3222	3/16"	4-1/2"
3223	1/4"	4-1/2"

STAINLESS STEEL CLEANER & PROTECTANT KIT

- Feeney SteelRenewal™ & SteelProtect™ make it easy to clean and maintain all stainless steel surfaces, fittings, and cables
- Kit includes a bottle of SteelRenewal™ & SteelProtect™, applicator brush, sponge, and protective gloves
- Non-toxic, biodegradable

Part#	Description
5064-PKG	Feeney SteelRenewal™ + Feeney SteelProtect™ (100 ml Bottle, each)

- ▲ **WARNING:** SteelRenewal™ can expose you to propylene glycol which has been determined by the State of California to cause cancer. For more information go to www.P65Warnings.ca.gov

CABLERAIL ACCESSORY KIT

- Handy kit for installing and maintaining CableRail cables and fittings
- Kit includes Stainless Steel Cleaner & Protectant Kit, Lacing Needle, Quick-Connect® Release Tool

Part#	Cable Size
CR-KIT	1/8" includes Multi-Tool
CR-KIT 3-16	3/16"

TENSION GAUGE (316-STAINLESS)

- Easy to use tool for checking cable tension

Part#	Description
6004-PKG	for 1/8", 3/16", 1/4" cables

CABLERAIL TENSIONING TOOL

- Easy to use tool for tightening cables
- Works on Quick-Connect® Inset fitting to efficiently pull cable through the fittings and maximize cable tension on long runs

Part#	Description
6005-PKG	for quickly tensioning cables
5071	Adapter for 3/16" and 1/4" cable





Argent Fabrication, Seattle, WA



Select Decks, Morgantown, WV

How to Handle Stairs

The most common solutions for stair installations with CableRail

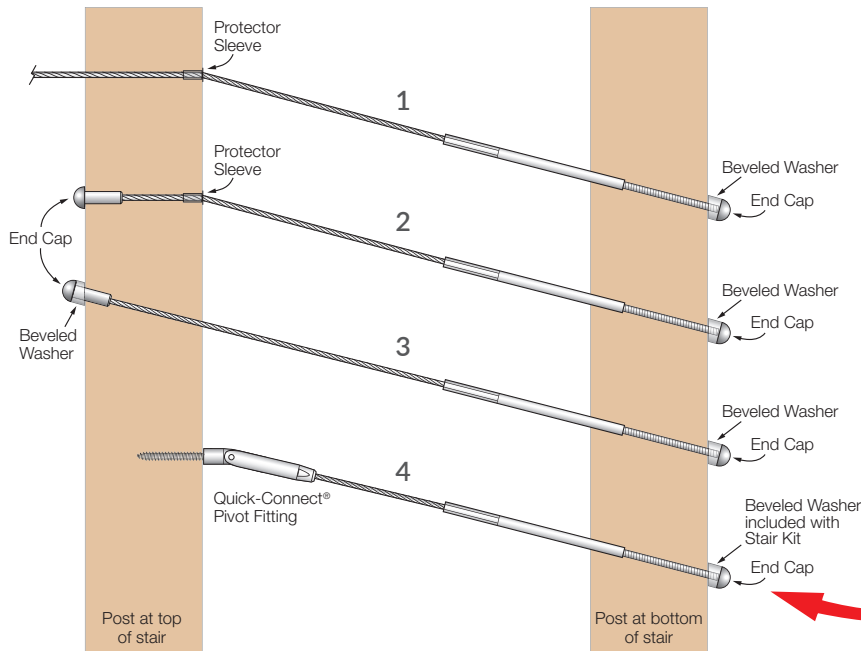

#6520-PKG CABLERAIL STAIR KIT

(All Stainless Steel)

- For wood posts only
- Typically used where there is little or no access to back side of top stair post/wall

Each assembly includes 20-ft of 1/8-in stainless cable with a 7 1/2-in Threaded Terminal pre-attached to one end, one Quick-Connect® Pivot Fitting, one 1/4-20RH Snug-Grip® Washer Nut, one 3/4" OD x 9/32" ID Beveled Washer, one 1" OD x 3/8" ID Flat Washer.

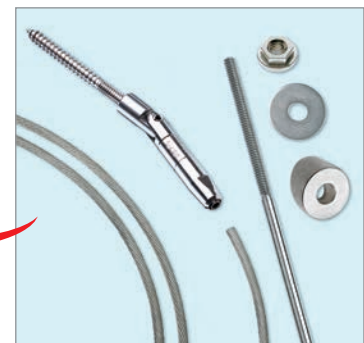

- Option 1: Kit or All-Thread Receiver Kit with cable bending and continuing.
- Option 2: Kit or All-Thread Receiver Kit with cable bending and terminating.
- Option 3: Kit or All-Thread Receiver Kit with angled holes and beveled washers on both ends.
- Option 4: New 20-ft CableRail Stair Kit #6520-PKG

Protector Sleeves, End Caps, and Beveled Washers sold separately (Beveled Washer included in Stair Kit #6520-PKG)

8 Easy Installation Steps

Complete step-by-step installation instructions and details are available at www.feeneyinc.com

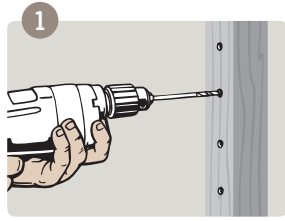

1 Measure, mark, and drill holes in all posts.

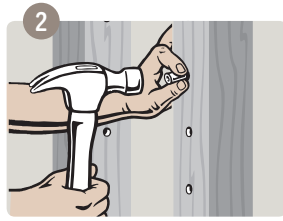

2 Insert Protector Sleeves (wood posts) or Grommets/Isolation Bushings (metal posts) at necessary locations.

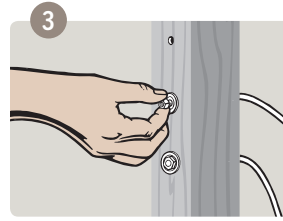

3 Insert the Threaded Terminal into one end termination post and secure with a Snug-Grip® Washer Nut. Spin Nut 2 to 3 turns.

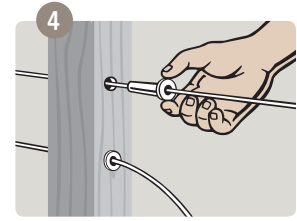

4 Lace the free end of the cable through the remaining posts and slide on a Quick-Connect® Inset fitting.

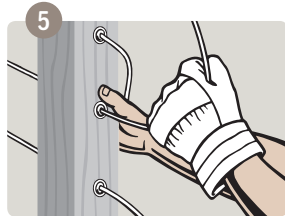

5 Pull the cable through the Quick-Connect® Inset fitting to remove the excess slack in the line. Tensioning Tool #6005-PKG may be used.

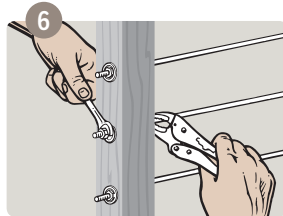

6 Tighten the Snug-Grip® Washer Nuts to adjust the final tension in the line. Tension Gauge #6004-PKG may be used to check uniform tension.

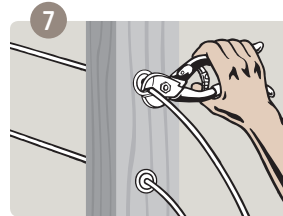

7 Trim the excess threads on the Threaded Terminal and excess cable behind the Quick-Connect® Inset fitting.

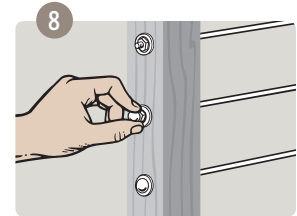

8 Snap on decorative End Caps over the exposed ends of the Quick-Connect® Inset fittings and Snug-Grip® Washer Nuts.

Cables can either terminate or run through corner posts.

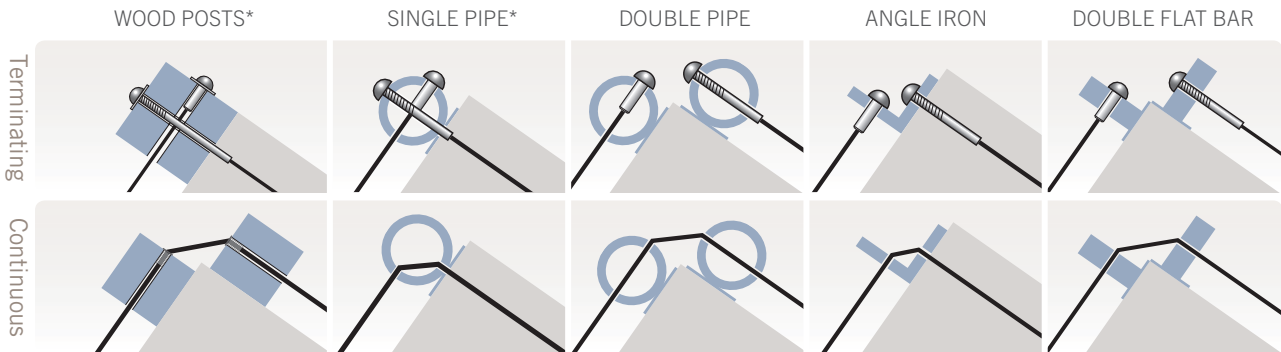

*Offset drill holes at least 1/2" if you choose to have cables terminating at a single wood or pipe post.

CONSTRUCTION CHECKLIST

- Space cables no more than 3-in apart
- Space posts/verticals no more than 3-ft apart
- Use minimum end/corner post sizes shown on page 38
- Securely fasten all posts and cap rails
- Carefully plan all termination and corner posts for proper clearance, positioning, and maximum cable run lengths

IMPORTANT NOTES

- Since building codes vary by state, county, and city, our recommendations may not comply with code requirements in all areas. Always consult with your local building department before starting your project.
- CableRail cable assemblies and fittings are designed for use on railings, fences, and trellises only. They should never be used for lifting, hanging, or high load applications.

CableRail Conceal Kits

CableRail gets even sleeker!

If you are interested in a very low-profile CableRail option, check out our new CableRail Conceal Kits with slender end caps and special compact cable fittings that hide inside your end posts for a completely symmetrical look.

- New low-profile offering for CableRail product line
- Creates a symmetrical look on both ends of the assembly with no exposed threaded terminal
- Uses 1/8-in diameter, 316-grade stainless for lasting durability and beauty
- Specially designed tension fitting on one end and a Conceal Quick-Connect® fitting on the other end for easy installation
- Sold in pre-cut assembly lengths (from 5-ft to 50-ft in increments of 5-ft) that can be trimmed to size in the field
- For use with DesignRail® aluminum railings and wood railings

Comparing Cable Rail Kits

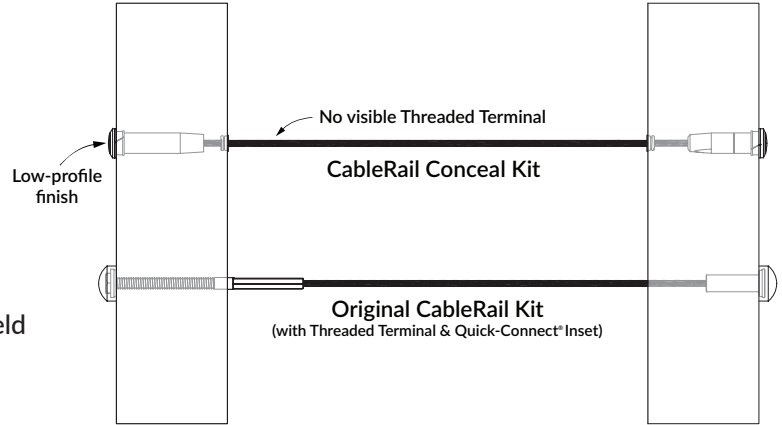

CableRail Conceal Kit contents:

1a 1/8-in diameter cable with Conceal Terminal pre-attached to one end

1b Conceal Receiver

1c Conceal Quick-Connect® fitting

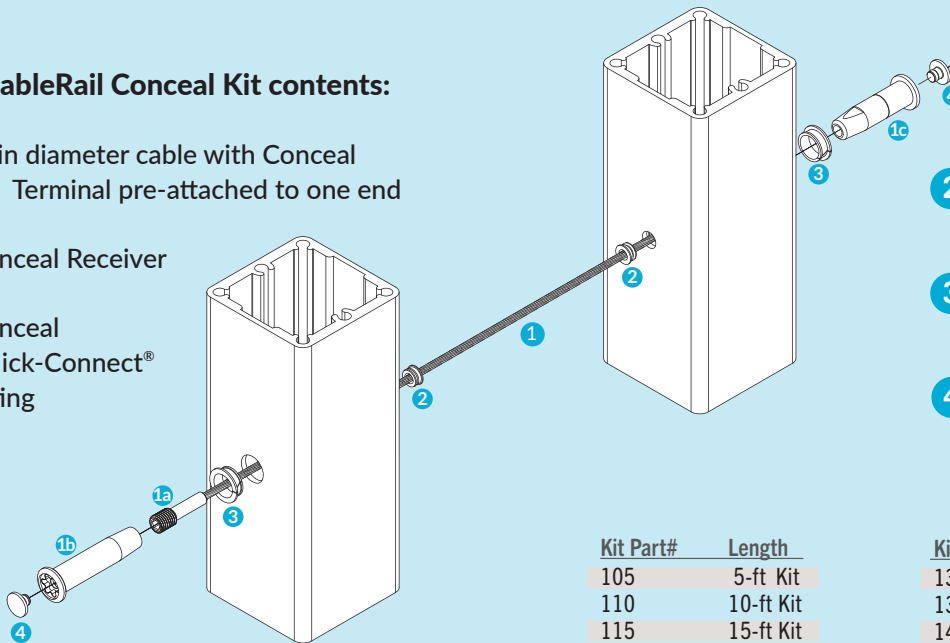

Accessories (sold separately):

- 2** Decorative or isolation bushings (depending on post type and stair vs level condition)
- 3** Bushings, flat washer, or beveled washer (depending on post type and stair vs level condition)
- 4** Conceal Caps (decorative stainless steel or colored end caps to match DesignRail® railings)

Kit Part#	Length
105	5-ft Kit
110	10-ft Kit
115	15-ft Kit
120	20-ft Kit
125	25-ft Kit

Kit Part#	Length
130	30-ft Kit
135	35-ft Kit
140	40-ft Kit
145	45-ft Kit
150	50-ft Kit

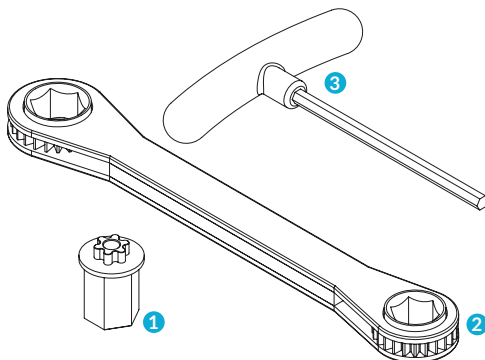

Conceal Tool Kit #CRC-KIT Includes:

- 1** Conceal Star Driver (can be purchased separately, Part# CSDT)
- 2** 1/2-in and 3/16-in Ratcheting Box Wrench
- 3** 5/32-in T-Handle HexWrench

Conceal Cap Removal Tool #CCRT

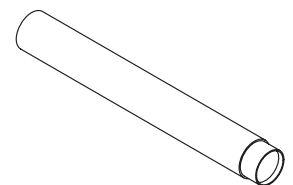

HOW TO ORDER CABLERAIL KITS

- 1) **Carefully Review:** Read all of the product information provided in this catalog and on our website www.feeneyinc.com. If you have questions, please call our sales department for assistance, 1-800-888-2418.
- 2) **Select Assembly Lengths:** Locate the cable termination posts where you will start and end your cables. Straight runs should not exceed 70-ft, and runs with bends (2 bends at most) NOT over 40-ft. Select assemblies that are at least one foot longer than the length of your railing sections.
- 3) **Determine Quantities:** The number of assemblies depends on your railing design. Remember to space cables no more than 3-in apart.
- 4) **Check Accessories:** Count all the end caps, protector sleeves, grommets, bushings, beveled washers, and tools you will need.
- 5) **Place The Order:** Visit an authorized Feeney dealer to purchase items. To locate a dealer in your area, click the dealer locator at www.feeneyinc.com or give us a call.

FREE: 1-800-888-2418

PH: 1-510-893-9473

FAX: 1-510-788-6041

SALES@FEENEYINC.COM

WWW.FEENEYINC.COM

A FEW WORDS ABOUT STAINLESS STEEL

The protective chromium oxide film on the surface of stainless steel gives it superior corrosion resistance. Properly maintained stainless steel provides excellent luster, strength, and durability. In most applications, stainless steel will not rust or stain even after years of service, but it is NOT rust or stain proof. When stainless comes in contact with chloride salts, sulfides, or other rusting metals, it can discolor or even rust and corrode. With proper care and maintenance, however, stainless steel can remain beautiful and functional for years to come, even when exposed to marine environments, polluted surroundings, salted highways, or other corrosive elements. For complete care and maintenance instructions, please visit www.feeneyinc.com.

Railing Frame Requirements

It is very important that your railing frames be designed and built strong enough to support the tension of properly installed cables, which is a load of at least 300 lbs for each cable. Frames can also be designed to use cables more efficiently, thereby reducing the total quantity of cable assemblies needed and the overall cost.

Special consideration must be given to the following:

- Size of the end and corner posts
- Spacing of posts from walls
- Spacing between posts and verticals
- Secure attachment of posts to the deck structure and cap rail
- Height of the railing
- Spacing of the cables

For more information on how to properly prepare your railing frames, please see the Frame Requirements section on pages 38 & 39 of this catalog. Visit our website www.feeneyinc.com for the most complete details.



10 YEAR LIMITED WARRANTY

Feeney, Inc. warrants that all CableRail stainless steel cable and connectors shall be free from defects in material and workmanship under normal use, conditions, installation, and maintenance in accordance with product specifications for ten (10) years from date of purchase. The complete warranty is available on our website www.feeneyinc.com.

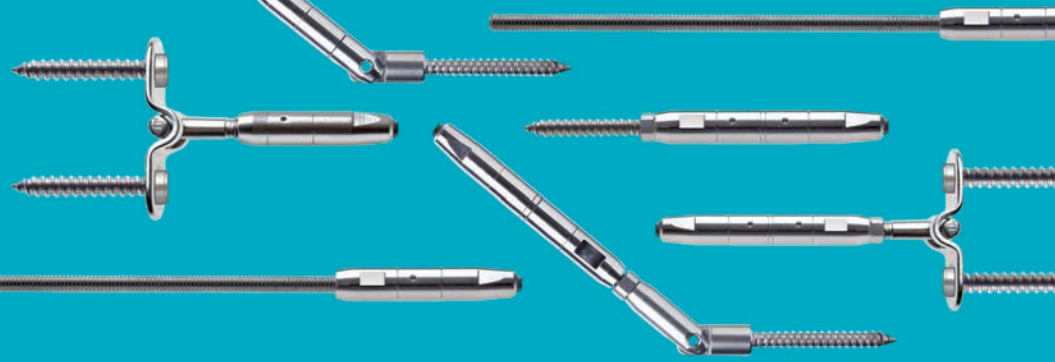

CABLE·RAIL[®] Custom Assemblies

Architectural Hardware That Anticipates Cable Design.

Projects with special installation conditions or design considerations may require certain styles of cable and fittings not addressed by our CableRail Kits. To fulfill those specific design and function needs, Feeney offers a wide assortment of cables, turnbuckles, terminals, adjusters, and fixed ends for custom assemblies. You can either order individual components and build your own assemblies, or let us fabricate them for you, ready to install.

- Wide selection of cables and fittings to meet any design requirement
- Made from high-quality 316-grade stainless steel with a tumbled satin finish for weather-tough durability, low maintenance, and lasting beauty
- Versatile uses include railings, trellises, fences, exteriors, interiors, residential, commercial
- Assemblies may be fabricated at your job site or in our factory, ready to install
- Detail drawings and 3-part specifications available at www.feeneyinc.com
- Toll-free design assistance and technical support line, 1-800-888-2418
- Product contains recycled materials 







Attaching the Fittings

Fittings can be attached to the cable either at our factory or in the field.

Machine Swaging (swā'j'ing)

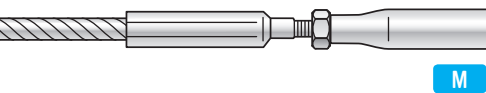

M

Machine swage fittings are attached to the cable at our factory using a hydraulic cold forming press. The swage shank portion of the fitting is pressed on to the end of the cable and has a uniform hexagonal shape when finished. Assemblies using Machine Swage type fittings are fabricated to your exact lengths in our factory and then shipped ready to install.

CableCrimp Hand Swaging



C

CableCrimp style fittings are attached to the cable by hand in the field using a special CableCrimp Crimper tool (#37 ge 34). After proper crimping, the fitting will display several evenly spaced compression marks where the tool was engaged. Most 1/8-in and 3/16-in cable fittings are available in CableCrimp styles.

Quick-Connect® Swageless (See pages 28-31)



QC

Quick-Connect® style fittings with automatic-locking jaws are attached to the cable in the field without any tools. The cable end is simply inserted into the fitting and the spring-loaded one-way jaws grab and lock on. If necessary, a reusable release tool (see page 34) can be used to disengage and remove or readjust the fitting. Available in an assortment of fitting styles.

Important Note: CableRail custom cables, fittings, and assemblies are only intended for use on railings, fences, and trellises and should never be used for lifting, hanging, load-bearing, or other potentially dangerous applications.

All of our cables and fittings are manufactured from high-quality 316-grade stainless steel with a tumbled satin finish for weather-tough durability, low maintenance, and lasting beauty.



CABLE·RAIL®

316-GRADE STAINLESS STEEL Cable

The usual choices for railings and architectural applications are uncoated 1/8-in, 3/16-in, and 1/4-in diameter 1x19 and 7x7 cables of 316-grade stainless steel. The reasons: versatility, aesthetics, low maintenance, longevity, and high abrasion resistance.

Part#	CableØ	Construction
4140	1/8"	1x19
4126	1/8"	7x7
4117	3/16"	1x19
4129	3/16"	7x7
4118	1/4"	1x19
4200	1/4"	7x7

1X19 CONSTRUCTION CABLES

- 19 individual wires twisted into a single, semi-flexible strand
- Excellent for railings, fences, and trellises with straight runs or slight bends

7X7 CONSTRUCTION CABLES

- 49 individual wires woven into a flexible strand
- Best for conditions that require tighter bends or for designs where a more woven wire appearance is desired

Also available: clear and colored vinyl and nylon coated cables and a wide assortment of other stainless, galvanized, and bright steel cables and wire ropes. For details, call our toll-free information line, 1-800-888-2418.

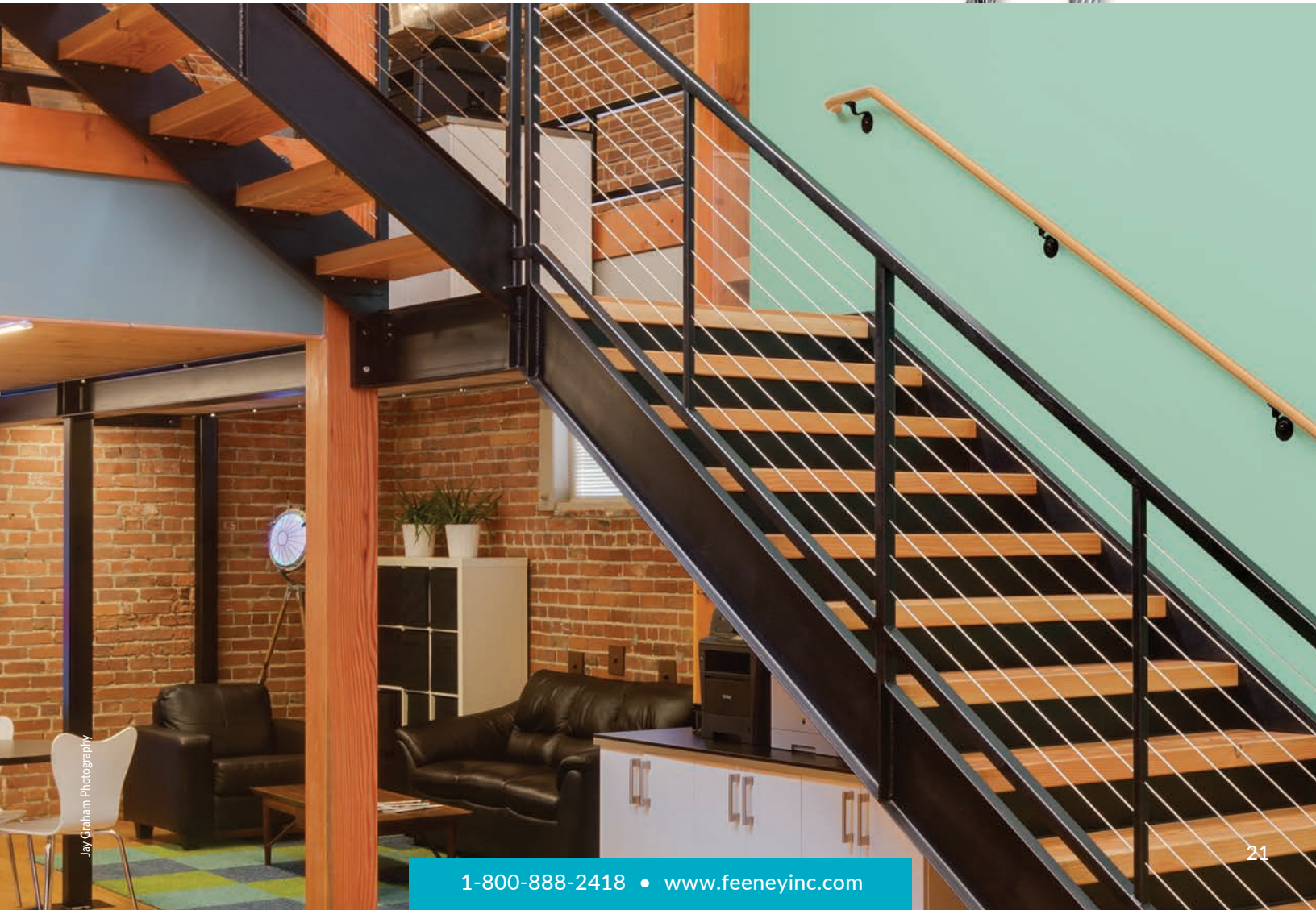
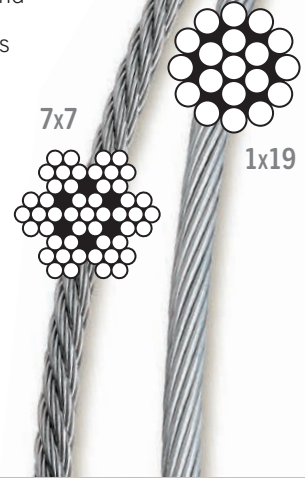

Cable Fittings

THERE ARE TWO TYPES OF CABLE FITTINGS

1 TENSION ADJUSTMENT FITTINGS (TAF)

- Includes Threaded Terminals, Turnbuckles, and Adjusters that are used to tighten the cable lines
- Tension is adjusted by tightening the nut on the Threaded Terminals, spinning the tubular body on the Turnbuckles, or rotating the bolt on the Adjusters
- Tension Adjustment fittings can be paired with either a Fixed End or another Tension Adjustment Fitting

2 FIXED ENDS (FE)

- Non-adjustable end termination fittings, sometimes referred to as “dead ends”
- Have no tensioning capabilities
- Each Fixed End must be paired with at least one Tension Adjustment Fitting

Every cable assembly must have at least one Tension Adjustment Fitting in order to tension the line. The diagram below shows the 3 common fitting positions.

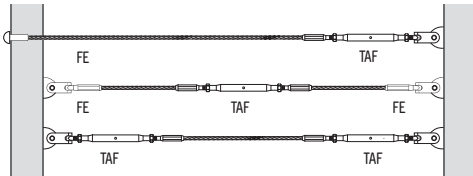

Tension Adjustment Fittings

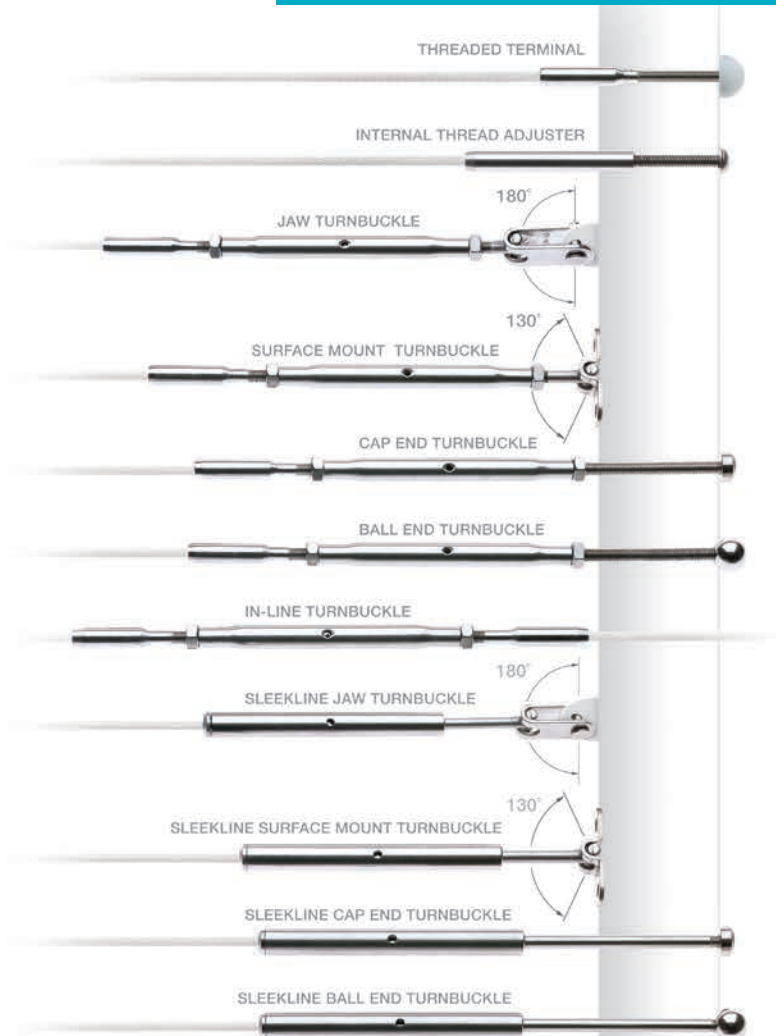

Fixed Ends

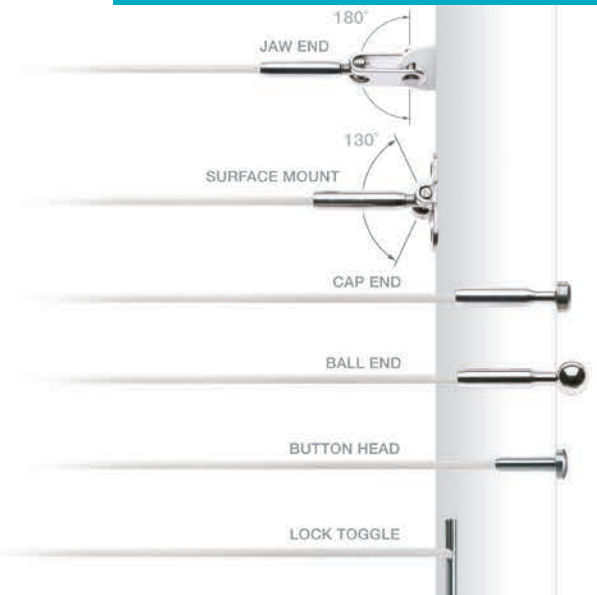

316-GRADE STAINLESS STEEL

Tension Adjustment Fittings

Stainless steel Threaded Terminals, Turnbuckles, and Adjusters provide tension to the cable lines. Tension is adjusted by tightening the nuts on the Threaded Terminals, spinning the tubular bodies on the Turnbuckles, or rotating the bolt on the Adjusters. Every cable assembly must include at least one Tension Adjustment Fitting.

THREADED TERMINAL

- Inserts through a drill hole in the end post and is secured and adjusted with a washer and nuts (sold separately, pages 32 & 33)
- Use beveled washers for angled stair terminations and flat washers (page 33) for added bearing surface on wood posts
- Typically paired with another Threaded Terminal

Note on charts: DrillØ is the recommended drill hole size for attaching the fittings to the end posts. Drill hole sizes for all other intermediate posts may differ. Please call to confirm correct drill sizes.

Part#	Swage	CableØ	Thread	T	L	SBØ	DrillØ
3168	M	1/8"	1/4-20RH	1"	2-1/2"	1/4"	5/16"
3191	M	1/8"	1/4-20RH	2-1/4"	4-1/4"	1/4"	5/16"
3193	M	1/8"	1/4-20RH	2-3/4"	7-1/2"	1/4"	5/16"
3197	M	1/8"	1/4-28RH	2-3/8"	4-1/4"	1/4"	5/16"
3250	M	1/8"	1/4-28LH	2-1/2"	3-3/4"	1/4"	5/16"
3157	M	3/16"	1/4-20RH	1"	2-5/8"	11/32"	3/8"
3253	M	3/16"	1/4-20RH	2-5/8"	4-1/4"	11/32"	3/8"
3256	M	3/16"	1/4-20RH	2-7/8"	7-1/2"	11/32"	3/8"
3198	M	3/16"	1/4-28RH	2-1/2"	4-1/4"	11/32"	3/8"
3254	M	3/16"	1/4-28LH	2-12"	4-1/4"	11/32"	3/8"
5050	M	1/4"	5/16-24RH	2-5/8"	4-3/4"	7/16"	7/16"
3249	M	1/4"	5/16-24LH	2-3/4"	4-3/4"	7/16"	7/16"
3260	C	1/8"	1/4-20RH	2-1/4"	4-1/4"	7/32"	5/16"
3251	C	1/8"	1/4-20RH	2-3/4"	7-1/2"	7/32"	5/16"
3190	C	1/8"	1/4-28RH	2-1/2"	4-1/2"	7/32"	5/16"
3247	C	1/8"	1/4-28LH	2-1/2"	4-1/2"	7/32"	5/16"
3263	C	3/16"	1/4-20RH	2-5/8"	4-7/8"	9/32"	3/8"
3264	C	3/16"	1/4-20RH	5-1/2"	7-7/8"	9/32"	3/8"
3192	C	3/16"	1/4-28RH	2-1/2"	4-3/4"	9/32"	3/8"
3248	C	3/16"	1/4-28LH	2-1/2"	4-3/4"	9/32"	3/8"

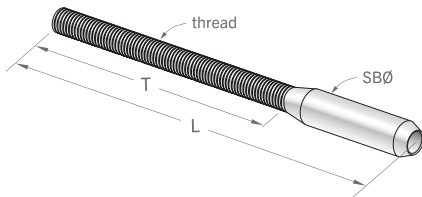

IN-LINE TURNBUCKLE

- Used in the middle of a cable assembly for additional tensioning on long runs or where end tensioning is not feasible or desired
- Can be combined with any Tension Adjustment Fitting or Fixed End

Part#	Swage	CableØ	Thread	L close (open)
3289	M	1/8"	1/4-28	7-1/2" (10-1/2")
3731	M	3/16"	1/4-28	8-1/2" (11-1/2")
3291	M	1/4"	5/16-24	9-1/2" (13-1/4")
3292	C	1/8"	1/4-28	9" (12")
3293	C	3/16"	1/4-28	9-1/2" (12-1/2")

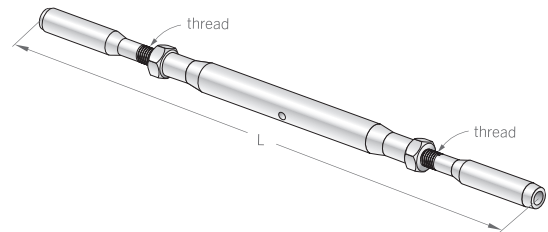

INTERNAL THREAD ADJUSTER

- Inserts through a drill hole in end post and is secured and adjusted using a bolt and washer (included)
- Use beveled washer (#3791, page 33) for angled stair terminations
- Typically paired with another Internal Thread Adjuster

Part#	Swage	CableØ	Thread	WØ	L close (open)	SBØ	DrillØ
3266-1.5	M	1/8"	10-24RH	7/16"	2-3/4" (3-3/4")	1/4"	5/16"
3266-2	M	1/8"	10-24RH	7/16"	3-1/4" (4-1/4")	1/4"	5/16"
3266-3	M	1/8"	10-24RH	7/16"	4-1/4" (5-1/4")	1/4"	5/16"
3267-1.5	M	3/16"	1/4-20RH	11/16"	3-1/4" (4-1/4")	11/32"	3/8"
3267-2	M	3/16"	1/4-20RH	11/16"	3-3/4" (4-3/4")	11/32"	3/8"
3267-3	M	3/16"	1/4-20RH	11/16"	4-3/4" (5-3/4")	11/32"	3/8"

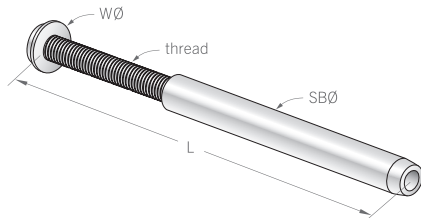

M Machine Swage

C CableCrimp Hand Swage

See pages 32-35 for accessory items and tools

316-GRADE STAINLESS STEEL Tension Adjustment Fittings

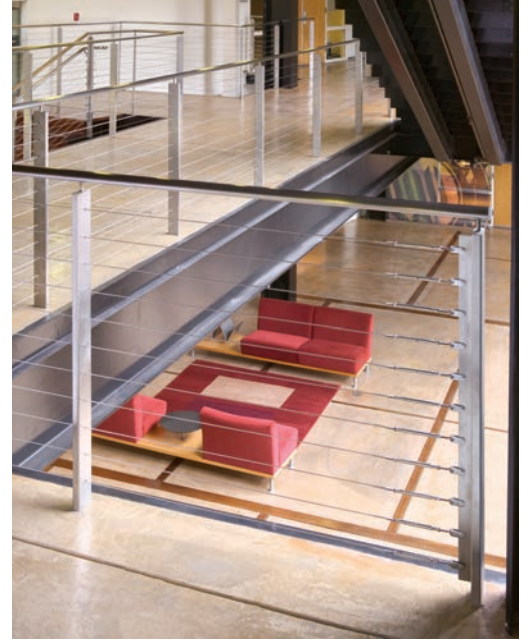

JAW TURNBUCKLE

- Attaches to fixed eyebolts, eyelets, or drilled tabs using a removable clevis pin
- 180° pivoting makes these ideal for angled stair terminations
- Typically paired with a Jaw End or another Jaw Turnbuckle

Part#	Swage	CableØ	Thread	PinØ	G	L close (open)	Pin DrillØ
3270	M	1/8"	1/4-28	1/4"	5/16"	7-3/4" (10-3/4")	5/16"
3271	M	3/16"	1/4-28	1/4"	5/16"	8-1/4" (11-1/4")	5/16"
3332	M	1/4"	5/16-24	5/16"	3/8"	9-1/4" (13")	3/8"
3268	C	1/8"	1/4-28	1/4"	5/16"	8-1/2" (11-1/2")	5/16"
3269	C	3/16"	1/4-28	1/4"	5/16"	8-3/4" (11-3/4")	5/16"

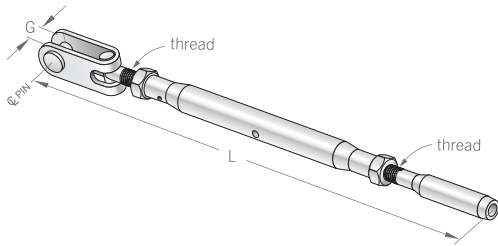

CAP END TURNBUCKLE

- Inserts through a drill hole in the end post and is secured with a screw-on end cap
- Use beveled washer (#3793) for angled stair terminations and flat washers (page 33) for added bearing surface on wood posts
- Typically paired with a Cap End or another Cap End Turnbuckle

Part#	Swage	CableØ	Thread	CØ	A* close	L close (open)	DrillØ
3325	M	1/8"	1/4-28	9/16"	1-3/8"	7-3/4" (10-3/4")	5/16"
3326	M	3/16"	1/4-28	9/16"	1-3/8"	8-1/4" (11-1/4")	5/16"
3327	M	1/4"	5/16-24	9/16"	3"	10-1/2" (14-1/4")	3/8"
3328	C	1/8"	1/4-28	9/16"	1-3/8"	8-1/2" (11-1/2")	5/16"
3329	C	3/16"	1/4-28	9/16"	1-3/8"	8-3/4" (11-3/4")	5/16"

* Longer shaft lengths available

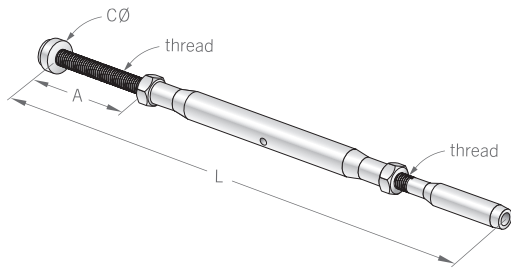

Note on charts: **DrillØ** is the recommended drill hole size for attaching the fittings to the end posts. Drill hole sizes for all other intermediate posts may differ. Please call to confirm correct drill sizes.

M Machine Swage

C CableCrimp Hand Swage

See pages 32-35 for accessory items and tools

SURFACE MOUNT TURNBUCKLE

- Attaches to face of the end post using lag screws or bolts (page 32)
- 130° pivoting allows for angled stair terminations
- Typically paired with a Surface Mount or another Surface Mount Turnbuckle

Part#	Swage	CableØ	Thread	EØ	H	W	L close (open)
3278	M	1/8"	1/4-28	1/4"	1-5/16"	5/8"	7" (10")
3277	M	3/16"	1/4-28	1/4"	1-5/16"	5/8"	7-1/2" (10-1/2")
3338	M	1/4"	5/16-24	5/16"	1-1/2"	3/4"	8-1/4" (12")
3275	C	1/8"	1/4-28	1/4"	1-5/16"	5/8"	7-3/4" (10-3/4")
3276	C	3/16"	1/4-28	1/4"	1-5/16"	5/8"	8" (11")

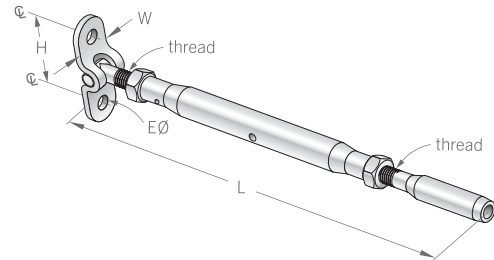

BALL END TURNBUCKLE

- Inserts through a drill hole or slot in end post and is secured with a screw-on ball
- Ball pivots to allow angled stair terminations without beveled washers
- Typically paired with a Ball End or another Ball End Turnbuckle

Part#	Swage	CableØ	Thread	DØ	A* close	L close (open)	DrillØ**
3340	M	1/8"	1/4-28	5/8"	1-1/4"	7-1/2" (10-1/2")	5/16"
3341	M	3/16"	1/4-28	5/8"	1-1/4"	8" (11")	5/16"
3342	M	1/4"	5/16-24	5/8"	2-7/8"	10-1/4" (14")	3/8"
3343	C	1/8"	1/4-28	5/8"	1-1/4"	8-1/4" (11-1/4")	5/16"
3344	C	3/16"	1/4-28	5/8"	1-1/4"	8-1/2" (11-1/2")	5/16"

* Longer shaft lengths available

** Ball can be slightly recessed into post by counterboring with 9/16" drill

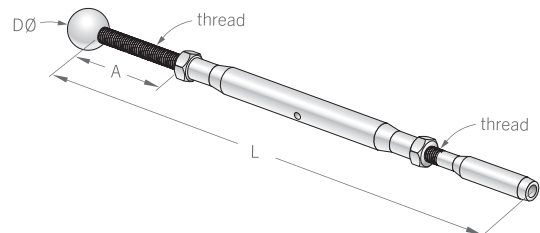

316-GRADE STAINLESS STEEL Tension Adjustment Fittings

THE SLEEKLINE SERIES TURNBUCKLES

have a swage sleeve hidden inside the body allowing a shorter turnbuckle design with clean lines and no exposed threads or swage ends. Sleekline Turnbuckles are best suited for attaching to the cable in the field using the CableCrimp™ style fittings and a CableCrimp™ Crimper tool (#3742, page 34).

SLEEKLINE JAW TURNBUCKLE

- Attaches to eyebolts, eyelets, or drilled tabs using a removable clevis pin
- 180° pivoting is ideal for angled stair terminations
- Typically paired with a Jaw End or another Sleekline Jaw Turnbuckle

Part#	Swage	CableØ	PinØ	TL	G	SØ	L close (open)	Pin DrillØ
3295	M	1/8"	1/4"	3/4"	5/16"	1/4"	6-3/8" (8")	5/16"
3296	M	3/16"						
3297	C	1/8"						
3299	C	3/16"						

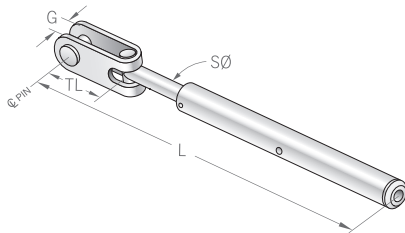

Note on charts: DrillØ is the recommended drill hole size for attaching the fittings to the end posts. Drill hole sizes for all other intermediate posts may differ. Please call to confirm correct drill sizes.

SLEEKLINE CAP END TURNBUCKLE

- Inserts through a drill hole in the end post and is secured with a screw-on end cap
- Use beveled washer (#3793) for angled stair terminations and flat washers (page 33) for added bearing surface on wood posts
- Typically paired with a Cap End or another Sleekline Cap End Turnbuckle

Part#	Swage	CableØ	CØ	A close	SØ	L close (open)	DrillØ
3300	M	1/8"	9/16"	3-1/2"	1/4"	8-1/4" (9-7/8")	5/16"
3302	M	3/16"					
3305	C	1/8"					
3282	C	3/16"					

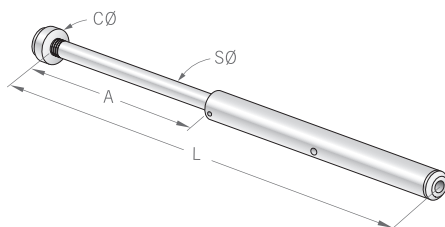

SLEEKLINE SURFACE MOUNT TURNBUCKLE

- Attaches to face of the post using lag screws or bolts (page 32)
- 130° pivoting allows for angled stair terminations
- Typically paired with a Surface Mount or Sleekline Surface Mount Turnbuckle

Part#	Swage	CableØ	EØ	H	W	SØ	L close (open)
3309	M	1/8"	1/4"	1-5/16"	5/8"	1/4"	5-5/8" (7-1/4")
3310	M	3/16"					
3311	C	1/8"					
3312	C	3/16"					

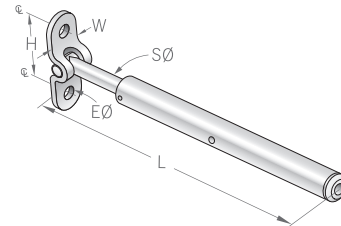

SLEEKLINE BALL END TURNBUCKLE

- Inserts through a drill hole or slot in the end post and is secured with a screw-on ball
- Ball pivots to allow angled stair terminations without beveled washers
- Typically paired with a Ball End or another Sleekline Ball End Turnbuckle

Part#	Swage	CableØ	DØ	A close	SØ	L close (open)	DrillØ*
3345	M	1/8"	5/8"	3-3/8"	1/4"	8-1/8" (9-3/4")	5/16"
3346	M	3/16"					
3350	C	1/8"					
3351	C	3/16"					

*Ball can be slightly recessed into post by counterboring with 9/16" drill.

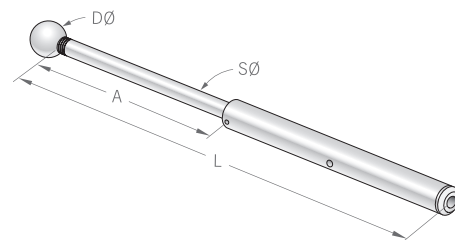

- M** Machine Swage
- C** CableCrimp Hand Swage

See pages 32-35 for accessory items and tools

316-GRADE STAINLESS STEEL

Fixed Ends

These stainless steel, non-adjustable end termination fittings have no tensioning capability. Therefore, each must be paired with at least one of the Tension Adjustment Fittings.



JAW END

- Attaches quickly to eyebolts, eyelets, or drilled tabs using a removable clevis pin
- 180° pivoting makes these ideal for angled stair terminations
- Typically paired with a Jaw Turnbuckle

Part#	Swage	CableØ	PinØ	TL	G	L	Pin DrillØ
3288	M	1/8"	1/4"	3/4"	5/16"	2-7/8"	5/16"
3331	M	3/16"	1/4"	3/4"	5/16"	3"	5/16"
3336	M	1/4"	5/16"	1"	3/8"	4-1/8"	3/8"
*3279	C	1/8"	1/4"	3/4"	5/16"	3-3/4"	5/16"
3280	C	3/16"	1/4"	3/4"	5/16"	3-3/4"	5/16"

* #3279 same as #3280 but includes insert sleeve for crimping onto 1/8" cable

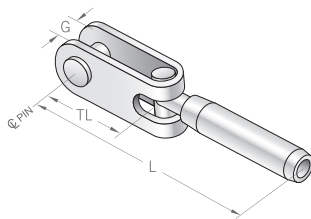

SURFACE MOUNT

- Attaches to the face of the end post using lag screws or bolts (page 32)
- 130° pivoting allows for easy angled stair terminations
- Typically paired with a Surface Mount Turnbuckle

Part#	Swage	CableØ	EØ	H	W	L
3281	M	1/8"	1/4"	1-5/16"	5/8"	2-1/8"
3284	M	3/16"	1/4"	1-5/16"	5/8"	2-1/4"
3337	M	1/4"	5/16"	1-1/2"	3/4"	3-1/4"
*3333	C	1/8"	1/4"	1-5/16"	5/8"	3"
3334	C	3/16"	1/4"	1-5/16"	5/8"	3"

* #3333 same as #3334 but includes insert sleeve for crimping onto 1/8" cable

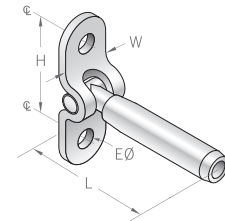

CAP END

- Inserts through a drill hole in the end post and is secured with a screw-on end cap
- Use beveled washers (#3793) for angled stair terminations and flat washers (page 33) for added bearing surface on wood posts
- Typically paired with a Cap End Turnbuckle

Part#	Swage	CableØ	Thread	CØ	CT	L	DrillØ
3315	M	1/8"	1/4-28RH	9/16"	5/16"	1-3/8"	5/16"
3316	M	3/16"	1/4-28RH	9/16"	5/16"	1-7/8"	3/8"
3317	M	1/4"	5/16-24RH	9/16"	5/16"	2-1/8"	7/16"
3318	C	1/8"	1/4-28RH	9/16"	5/16"	2"	5/16"
3319	C	3/16"	1/4-28RH	9/16"	5/16"	2-3/8"	3/8"

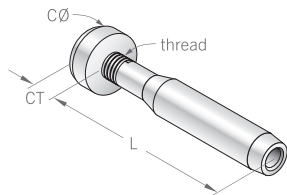

M Machine Swage

C CableCrimp Hand Swage

See pages 32-35 for accessory items and tools

316-GRADE STAINLESS STEEL

Fixed Ends

BALL END

- Inserts through a drill hole or slot in the end post and is secured with a screw-on ball
- Ball pivots to allow angled stair terminations without beveled washers
- Typically paired with a Ball End Turnbuckle

Part#	Swage	CableØ	Thread	DØ	L	DrillØ*
3352	M	1/8"	1/4-28RH	5/8"	1-1/4"	5/16"
3353	M	3/16"	1/4-28RH	5/8"	1-3/4"	3/8"
3354	M	1/4"	5/16-24RH	5/8"	2"	7/16"
3355	C	1/8"	1/4-28RH	5/8"	1-7/8"	5/16"
3356	C	3/16"	1/4-28RH	5/8"	2-1/4"	3/8"

* Ball can be slightly recessed into post by counterboring with 9/16" drill.

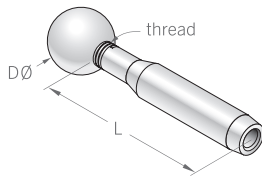

Note on charts: **DrillØ** is the recommended drill hole size for attaching the fittings to the end posts. Drill hole sizes for all other intermediate posts may differ. Please call to confirm correct drill sizes.

LOCK TOGGLE

- Used on tubular metal end posts where the design only allows for penetration of one side of the post
- The fitting passes through a drill hole and toggles into a locked position inside the post, leaving no exposed hardware
- Will accommodate angled stair conditions without beveled washers
- Typically paired with another Lock Toggle plus an In-Line Turnbuckle

Part#	Swage	CableØ	L	SBØ	DrillØ
3169	M	1/8"	1-1/2"	1/4"	5/16"
3164	C	1/8"	1-1/2"	7/32"	5/16"

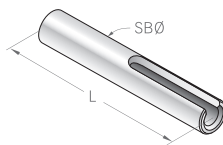

BUTTON HEAD

- Single piece fitting with a non-removable, low-profile rounded head
- Fits into a hole drilled through the end post, and the head rests against the outside face of the post
- Use beveled washers (#3791 for 1/8-in and #3793 for 3/16-in) for angled stair terminations and flat washers (page 33) for added bearing surface on wood posts
- Typically paired with another Button Head plus an In-Line Turnbuckle

Part#	Swage	CableØ	CØ	CT	L	DrillØ
3287	M	1/8"	7/16"	1/8"	1"	9/32"
3240	M	3/16"	1/2"	1/8"	1-1/8"	3/8"

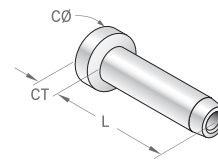

M Machine Swage

C CableCrimp Hand Swage

See pages 32-35 for accessory items and tools

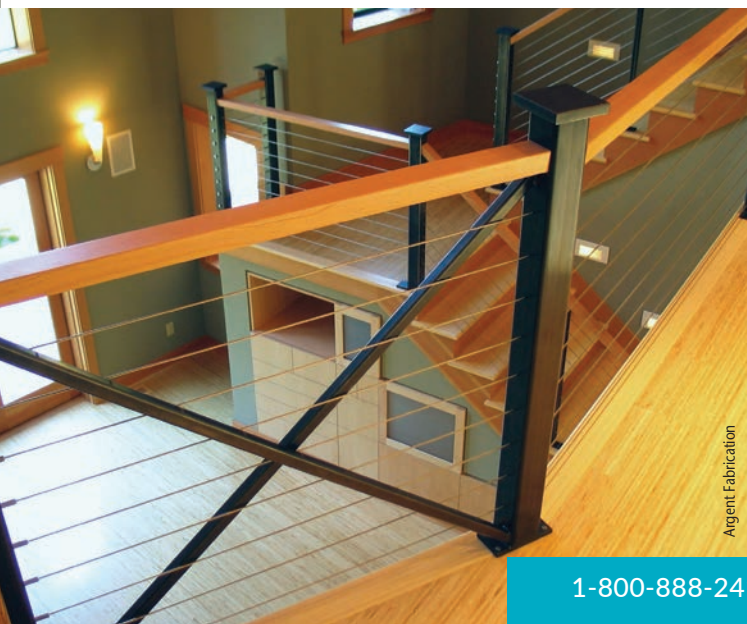

Argent Fabrication



INTRODUCING OUR NEW GENERATION OF Quick-Connect® cable hardware

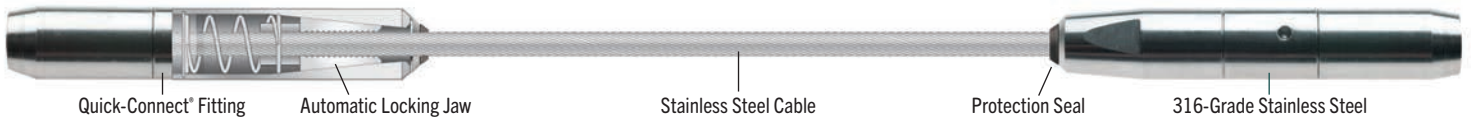

We've taken our automatic-locking-jaw design from our original Quick-Connect® Inset fitting and applied it to an entire line of cable end fittings. Now you can select from a wide variety of sleek and versatile cable end fittings that offer the flexibility of assembling cables in the field and the simplicity, speed, and gripping power of our Quick-Connect® jaws: no more cumbersome crimp tools or time consuming wedge-type compression fittings. Simply trim your cable to length, push the end into the Quick-Connect® fitting, and the spring-loaded jaws automatically engage. You're ready to go! Made from 316-grade stainless steel for weather-tough durability, low maintenance, and lasting beauty. Fittings also come with a silicone protection seal pre-inserted into the end, providing added protection against dirt and debris entering the body of the fitting. If necessary, a reusable release tool is available to disengage and remove or readjust the fitting (see pg 34).

There are 2 types of Quick-Connect® fittings:

1 TENSION ADJUSTMENT FITTINGS

- Include Threaded Terminals, Turnbuckles, Adjusters, and Tensioner fittings that are used to tighten the cable lines
- Tension is adjusted by tightening the nut on the Threaded Terminals, spinning the tubular body on the Turnbuckles and Tensioners, or rotating the bolt on the Adjusters
- Tension Adjustment fittings can be paired with either a Fixed End or another Tension Adjustment Fitting

2 FIXED ENDS

- Non-adjustable end termination fittings, sometimes referred to as "dead ends"
- Have no tensioning capabilities
- Each Fixed End must be paired with at least one Tension Adjustment Fitting



Trim cable to length

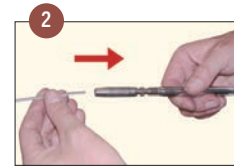

Insert cable into fitting

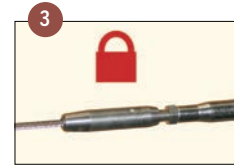

Jaws lock automatically



Fixed Ends

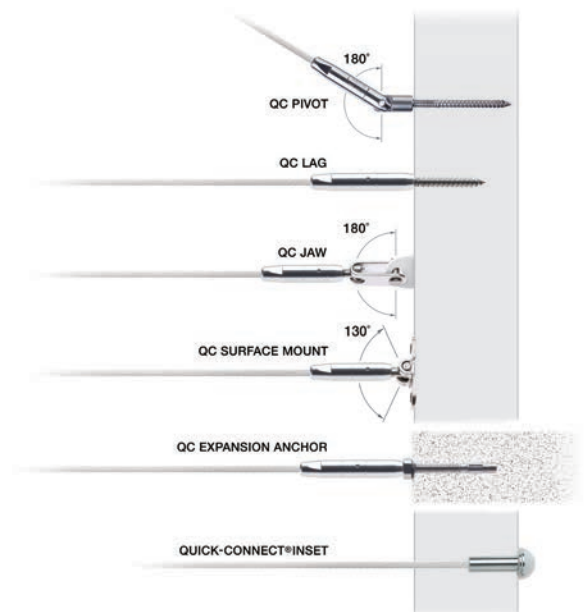

316-GRADE STAINLESS STEEL Quick-Connect® Fixed End Fittings

QUICK-CONNECT® INSET

- Fits into a hole drilled in end post, and the lip rests against the outside post face
- Design allows the cable to pass entirely through the fitting in one direction only; any excess cable is trimmed
- Use beveled washers for angled stair termination and flat washers (page 33) for added bearing surface on wood posts
- Exposed end is covered with colored or stainless End Caps (page 33)
- Can be paired with any Tension Adjustment Fitting

Part#	CableØ	CØ	BØ	L	DrillØ
3146	1/8"	5/8"	3/8"	1-1/8"	3/8"
3147	3/16"	3/4"	17/32"	1-5/8"	9/16"
3148	1/4"	3/4"	17/32"	1-5/8"	9/16"

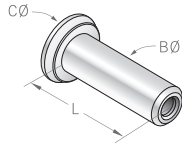

QUICK-CONNECT® SURFACE MOUNT

- Attaches to the face of a wall or post using screws or bolts (pg 32)
- 130° pivoting allows for easy angled stair terminations
- Typically paired with a Quick-Connect® Surface Mount Turnbuckle or Tensioner

Part#	CableØ	EØ	H	W	L	QCØ
9903W-PKG	1/8"	1/4"	1-5/16"	5/8"	2-1/2"	7/16"
9803	3/16"	5/16"	1-1/2"	3/4"	3-1/4"	9/16"

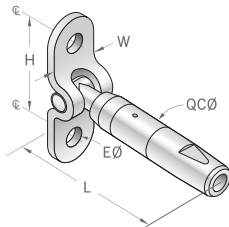

QUICK-CONNECT® LAG

- Screws into the face of a wood post or wall using a hanger bolt with lag thread (included)
- Can be paired with any Tension Adjustment Fitting

Part#	CableØ	Thread	T	L	QCØ	Pilot DrillØ
9905 DL-PKG	1/8"	1/4" lag	2"	4-1/4"	7/16"	*7/32"
9805	3/16"	5/16" lag	2"	5-1/4"	9/16"	*7/32"

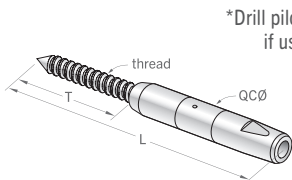

*Drill pilot hole slightly larger if using hardwood posts.

QUICK-CONNECT® JAW

- Attaches to eyebolts, eyelets, or drilled tabs using a removable clevis pin
- 180° pivoting make these ideal for angled stair terminations
- Typically paired with a Quick-Connect® Jaw Turnbuckle

Part#	CableØ	PinØ	TL	G	L	QCØ	Pin DrillØ
9901-PKG	1/8"	1/4"	7/8"	5/16"	3-1/4"	7/16"	5/16"
9801	3/16"	5/16"	1"	3/8"	4-5/8"	9/16"	3/8"

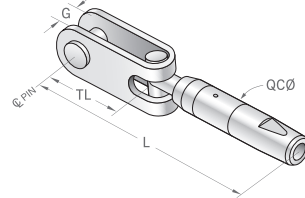

QUICK-CONNECT® PIVOT

- Screws into the face of a wood post or wall using a hanger bolt with lag thread (included)
- 180° pivoting allows for angled stair terminations
- Typically paired with a Quick-Connect® Pivot Tensioner

Part#	CableØ	Thread	T	L	QCØ	Pilot DrillØ
9915 DL-PKG	1/8"	1/4" lag	2"	4-3/8"	7/16"	*7/64"
9815	3/16"	5/16" lag	2"	5-1/2"	9/16"	*7/32"

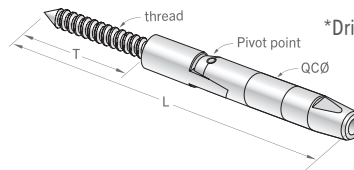

*Drill pilot hole slightly larger if using hardwood posts.

QUICK-CONNECT® EXPANSION ANCHOR

- Combines a 3/4-in diameter threaded expansion anchor (washer & nut included) with a Quick-Connect® body
- Attaches to concrete or masonry walls
- Can be paired with any Tension Adjustment Fitting

Part#	CableØ	Thread	T	L	QCØ	DrillØ
9906-PKG	1/8"	1/4-20	1-1/2"	4-1/8"	7/16"	1/4"

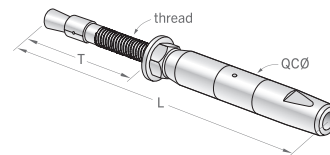

316-GRADE STAINLESS STEEL

Quick-Connect® Tension Adjustment Fittings

QUICK-CONNECT® THREADED TERMINAL

- Inserts through a drill hole in the post and is secured and adjusted with a washer nut (sold separately, page 32)
- Use beveled washers for angled stair terminations and flat washers (pg 33) for added bearing surface on wood posts
- Typically paired with another Quick-Connect® Threaded Terminal but can be paired with any other Fixed End or Tension Adjustment Fitting

Part#	CableØ	Thread	T	L	QCØ	DrillØ
9904-PKG	1/8"	1/4-20	5"	7-3/8"	7/16"	*5/16"
9804	3/16"	5/16-24	5"	7-3/8"	9/16"	*7/16"

*May counterbore with slightly larger diameter drill to embed Quick-Connect® body into post

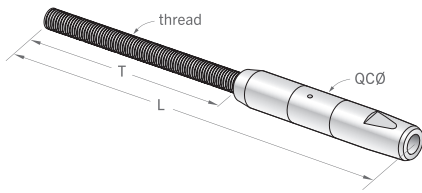

QUICK-CONNECT® JAW TURNBUCKLE

- Attaches to eyebolts, eyelets, or drilled tabs using a removable clevis pin
- 180° pivoting make these ideal for angled stair terminations
- 3 3/4-in of adjustability allows for maximum cable run lengths
- Typically paired with a Quick-Connect® Jaw or another Jaw Turnbuckle

Part#	CableØ	Thread	PinØ	G	L closed (open)	QCØ	Pin DrillØ
9900-PKG	1/8"	1/4-28	1/4"	5/16"	8-1/2" (11-3/4")	7/16"	5/16"

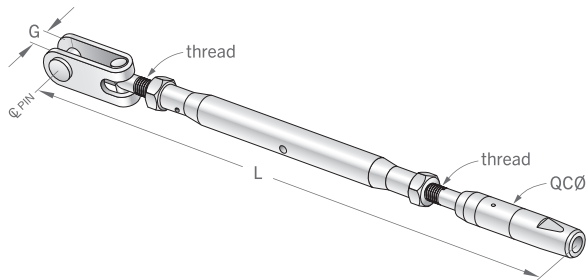

QUICK-CONNECT® INTERNAL THREAD ADJUSTER

- Inserts through a drill hole in the post and is secured and adjusted with a square drive bolt and washer (included). #9807 has 3/4-in hex head bolt
- Use beveled washer (page 33) for angled stair terminations
- Typically paired with another Quick-Connect® Internal Thread Adjuster but can be paired with any other Fixed End or Tension Adjustment Fitting

Part#	CableØ	Thread	BØ	WØ	L closed (open)	QCØ	DrillØ
9907-PKG	1/8"	1/4-20	7/16"	11/16"	2-3/4" (3-1/2")	7/16"	*5/16"
9908-PKG	1/8"	1/4-20	7/16"	11/16"	3-1/4" (4")	7/16"	*5/16"
9909-PKG	1/8"	1/4-20	7/16"	11/16"	4-1/4" (5")	7/16"	*5/16"
9807	3/16"	5/16-18	1/2"	3/4"	3-1/4" (4")	9/16"	*3/8"

*Drill Ø is clearance hole for threaded bolt shaft only. To embed the QC body into the post, drill a hole slightly larger than the QC Ø.

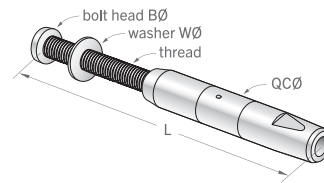

QUICK-CONNECT® SURFACE MOUNT TURNBUCKLE

- Attaches to the face of a wall or post using screws or bolts (page 32)
- 130° pivoting allows for easy angled stair terminations
- 3 3/4-in of adjustability allows for maximum cable run lengths
- Typically paired with a Quick-Connect® Surface Mount of another Surface Mount Turnbuckle

Part#	CableØ	Thread	EØ	H	W	L closed (open)	QCØ
9902W-PKG	1/8"	1/4-28	1/4"	1-5/16"	5/8"	7-3/4" (11")	7/16"

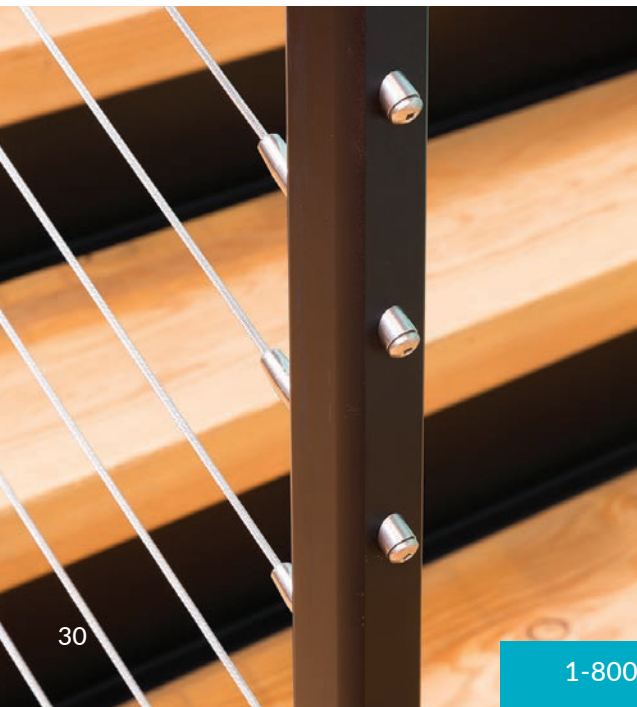
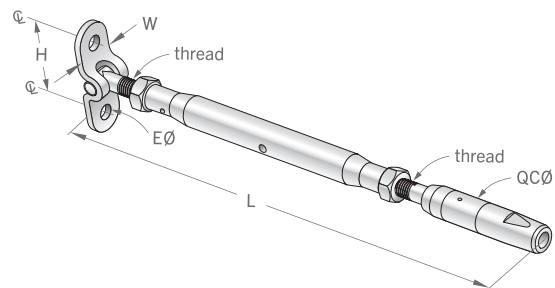

Tension Adjustment Fittings

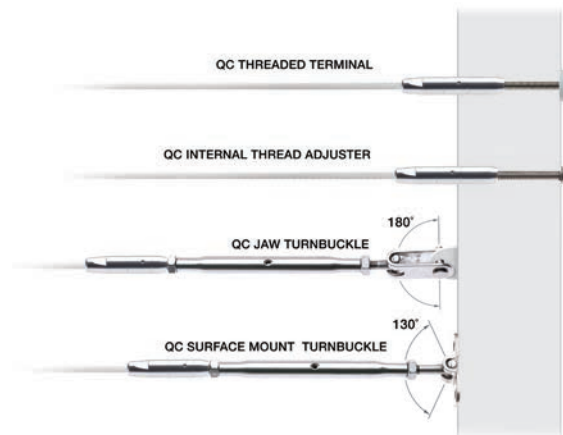

316-GRADE STAINLESS STEEL

Quick-Connect® Tension Adjustment Fittings

THE TENSIONER FITTINGS

have a special swiveling body that's integrated with the Quick-Connect® fitting creating a shorter overall design with a sleek appearance and fewer exposed threads. Machined flats allow wrenches to securely grip and spin the body to adjust tension without marring the polished surface. Tensioners are perfect for short to medium length cable runs.

QUICK-CONNECT® LAG TENSIONER

- Screws into the face of a wood post or wall using a hanger bolt with lag thread (included)
- Typically paired with a Quick-Connect® Lag or another Quick-Connect® Lag Tensioner

Part#	CableØ	Thread	T	L closed (open)	QCØ	DrillØ
9910DL-PKG	1/8"	1/4" lag	2"	5-1/4" (5-3/4")	7/16"	*7/64"
9810	3/16"	5/16" lag	2"	5-7/8" (6-7/8")	9/16"	*7/32"

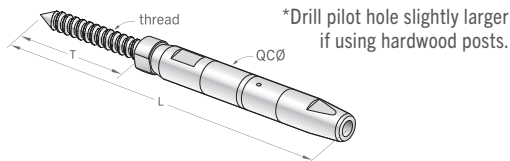

QUICK-CONNECT® PIVOT TENSIONER

- Screws into the face of a wood post or wall using a hanger bolt with lag thread (included)
- 180° pivoting allows for angled stair terminations
- Typically paired with a Quick-Connect® Pivot or another Quick-Connect® Pivot Tensioner

Part#	CableØ	Thread	T	L closed(open)	QCØ	DrillØ
9916DL-PKG	1/8"	1/4" lag	2"	7" (7-3/4")	7/16"	*7/64"
9816	3/16"	5/16" lag	2"	8" (9")	9/16"	*7/32"

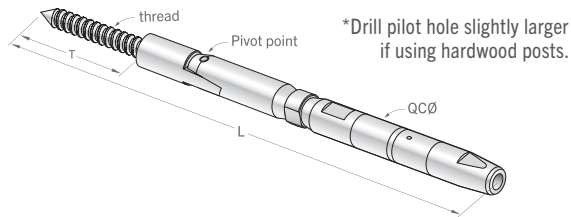

QUICK-CONNECT® SURFACE MOUNT TENSIONER

- Attaches to the face of a wall or post using screws or bolts (pg 32)
- 130° pivoting allows for angled stair terminations
- Typically paired with a Quick-Connect® Surface Mount or another Quick-Connect® Surface Mount Tensioner

Part#	CableØ	Thread	EØ	H	W	L closed (open)	QCØ
9913W-PKG	1/8"	1/4-20	1/4"	1-5/16"	5/8"	4" (4-3/4")	7/16"
9813	3/16"	5/16-18	5/16"	1-1/2"	3/4"	4-1/2" (5-1/2")	9/16"

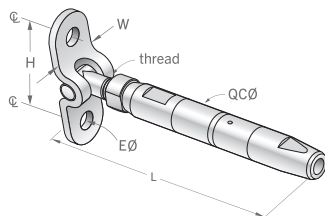

QUICK-CONNECT® JAW TENSIONER

- Attaches to eyebolts, eyelets or drilled tabs using a removable clevis pin
- 180° pivoting allows for angled stair terminations
- Typically paired with a Quick-Connect® Jaw End or another Quick-Connect® Jaw Tensioner

Part#	CableØ	Thread	Pin	G	L closed(open)	QCØ	Pin DrillØ
9912-PKG	1/8"	1/4-20	1/4"	5/16"	4-3/4" (5-1/2")	7/16"	5/16"
9812	3/16"	5/16-18	5/16	3/8"	5-3/8" (6-3/8")	9/16"	3/8"

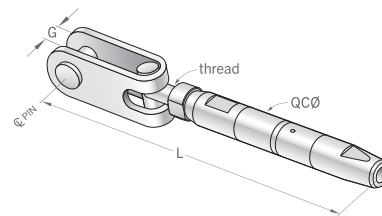

QUICK-CONNECT® EXPANSION ANCHOR TENSIONER

- Attaches to concrete or masonry walls or posts using a 3/4-in threaded expansion anchor (included with washer & nut)
- Typically paired with a Quick-Connect® Expansion Anchor or another Quick-Connect® Expansion Anchor Tensioner

Part#	CableØ	Thread	T	L closed(open)	QCØ	DrillØ
9914-PKG	1/8"	1/4-20	1-1/2"	4-1/4" (5")	7/16"	1/4"

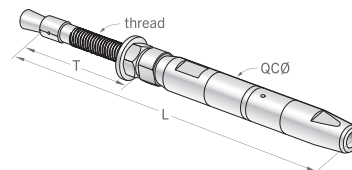

Tensioner Fittings

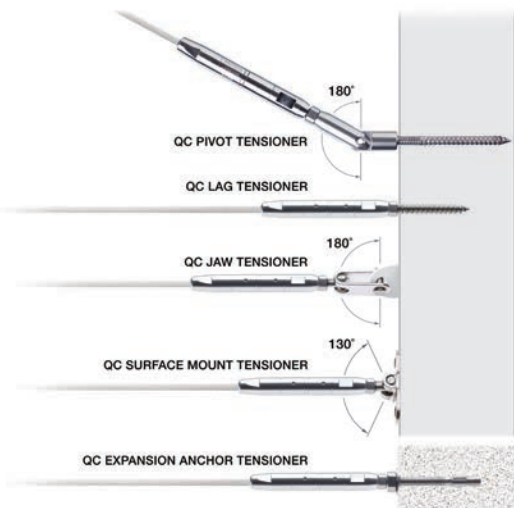

Nuts & Bolts



Photo: Marla Meris Imaging, Allwood Construction

BUTTON HEAD LAG SCREWS (316-Stainless)

- For attaching Surface Mount Fittings to wood posts
- Requires S2 square-drive bit

Part#	Size & Length
7918	1/4" x 2"

HEX HEAD LAG SCREWS (8-18-Stainless)

- For attaching Surface Mount Fittings to wood posts

Part#	Size & Length
3183	1/4" x 2"

HEX HEAD BOLTS (316-Stainless)

- For attaching Surface Mount Fittings to metal posts
- Drill and tap metal for 1/4-20RH threads

Part#	Thread & Length
3322	1/4-20RH x 3/4"

SNUG-GRIP® WASHER NUTS (316-Stainless)



- Option for securing Threaded Terminal fittings to posts
- It's a washer, retaining ring, and lock nut wrapped into one fitting
- Cable tension is adjusted by spinning the nut, and special Snug-Grip® threads help prevent loosening
- The raised lip allows for easy snap-on attachment of Colored and Stainless End Caps

Part#	Thread
3370	1/4-20RH
3371	5/16-24RH

HEX NUTS (316-Stainless)



- Option for securing Threaded Terminal fittings to posts
- Tension is adjusted by spinning the nut
- Typically used in conjunction with Cap Nuts to provide a finished detail

Part#	Thread
3143	1/4-20RH
3178	1/4-28RH
3243	1/4-28LH
3244	5/16-24RH
3242	5/16-24LH

NYLON INSERT LOCKNUTS (316-Stainless)



- Option for securing Threaded Terminal fittings to posts
- Tension is adjusted by spinning the nut, and an integrated nylon insert prevents the nut from loosening
- Typically paired with a Retaining Washer (#7070) and covered with a Colored End Cap

Part#	Thread
3121	1/4-20RH
3175	1/4-28RH

CAP NUTS (316-Stainless)



- Option for finishing and locking hex nuts on Threaded Terminal fittings

Part#	Thread
3144	1/4-20RH
3179	1/4-28RH
3188	5/16-24RH

PROTECTOR SLEEVES (316-Stainless)



- (For wood and composite sleeved wood posts) For protecting corner and stair transition posts from cable abrasion
- Use with 1/8-in and 3/16-in diameter cable
- Fits 1/4-in diameter drill holes

Part#	Size & Length	Flange
3210	1/4" x 7/8"	1/2"

SHOULDER EYEBOLT (316-Stainless)



- Option for attaching Jaw Fittings to posts
- Includes washer and hex nut for securing to post

Part#	Size & Length
5057	5/16-18RH x 4"



COLORED END CAPS (Polyethylene)

- Option for covering and finishing the exposed ends of Threaded Terminal nuts and Quick-Connect® Inset fittings
- Fits Washer Nuts, Retaining Washers, and Quick-Connect® Inset fittings
- Size 3/4"OD x 7/16"H

Part#	Color
7071	Black
7072	White
7073	Brown
7074	Gray
7075	Silver
7076	Taupe
7077	Bronze
7078	Green
7079	Cream

END CAPS (316-Stainless)

- Decorative option for covering and finishing the exposed ends of Quick-Connect® Inset and Snug-Grip® Washer Nuts
- Will not fit onto Retaining Washers
- Size 3/4"OD x 3/8"H



Part#	Style
3372	Dome
3373	Crown
3374	Chamfer

ISOLATION BUSHINGS (Engineered Polymer)

- For eliminating direct contact of dissimilar metals to minimize electrolysis when attaching cables and fittings to metal posts in areas with salt air or similar harsh elements
- Highly resistant to abrasion and UV degradation
- Wide operating temperature range, -40°F to +266°F
- Must use silicone sealant (not included) to secure bushings in posts



Part#	Size	*HoleØ
1101	3/16"ID x 1/4"OD, 3/8" flange	1/4"
1102	1/4"ID x 5/16"OD, 1/2" flange	5/16"
1104	9/32"ID x 23/64"OD, 19/32" flange	23/64"
1115	5/16"ID x 3/8"OD, 9/16" flange	3/8"
1100	3/8"ID x 15/32"OD, 11/16" flange	15/32"
1105	7/16"ID x 17/32"OD, 3/4" flange	17/32"
1118	15/32"ID x 35/64"OD, 25/32" flange	35/64"
1103	35/64"ID x 5/8"OD, 55/64" flange	5/8"

*Note: HoleØ is the required post hole size after any galvanized, paint, or powder coatings are applied to the metal frame. Metal frames are all different, so please call to confirm correct bushing sizes and corresponding hole diameters for your frame condition and cable fitting styles. Also see the Accessories section on our website: www.feeneyinc.com.



RETAINING WASHERS (304-Stainless)

- For attaching Colored End Caps over the Hex Nuts and Nylon Insert Lock Nuts
- Raised lip allows End Caps to easily snap and lock-on

Part#	Size x OD
7070	1/4" x 5/8"



FLAT WASHERS (316-Stainless)

- For providing additional bearing surface to end fittings on wood posts

Part#	Size x OD
3180	1/4" x 11/16"
3181	1/4" x 1"
3231	5/16" x 3/4"
3378	3/8" x 1"
3177	9/16" x 1"



FLAT WASHERS (Nylon)

- For protecting metal posts from nut abrasion and electrolysis

Part#	Size x OD	Color
3375	1/4" x 3/4"	White
3377	5/16" x 3/4"	White
3376	3/8" x 3/4"	White
3379	9/16" x 3/4"	White
3375-BLK	1/4" x 3/4"	Black
3377-BLK	5/16" x 3/4"	Black
3376-BLK	3/8" x 3/4"	Black
3379-BLK	9/16" x 3/4"	Black



BEVELED WASHERS (316-Stainless)

- For providing a flat bearing surface when attaching fittings at angled stair terminations
- 3 angle options to fit most stair conditions

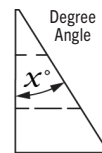

x°	x°	x°	Size x OD
26°-Part#	32°-Part#	37°-Part#	
N/A	3791	N/A	1/4" x 1/2"
3790	3799	3796	9/32" x 3/4"
N/A	3793	N/A	3/8" x 5/8"
3794	3792	3797	3/8" x 3/4"
3795	3798	3787	9/16" x 3/4"

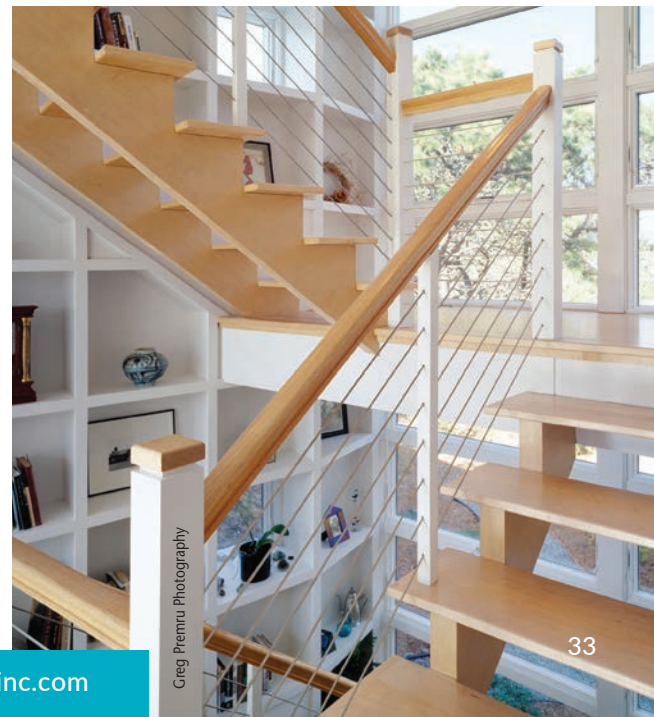

Helpful Tools

HANGER BOLT INSTALLATION TOOL

- For easily installing hanger bolts used in the Quick-Connect® Lag and Pivot fittings (pgs 29 & 31)

Part#	Internal Thread	Length
3988	1/4-20RH	7/8"
3989	5/16-18RH	7/8"



QUICK-CONNECT® RELEASE TOOLS

- For disengaging and removing or readjusting Quick-Connect® fittings

Part#	Description
3128	for 1/8" Quick-Connect®, Reusable
3158	for 3/16" Quick-Connect®, Reusable



QUICK-CONNECT® WRENCH WHEEL

- An easy to use tool for tensioning Quick-Connect® Tensioner fittings that allows for continuous full rotation without requiring repositioning of wrenches

Part#	Description
6006-PKG	for 1/8" Quick-Connect® Tensioners



CABLE LACING NEEDLES

- For quickly lacing cable ends through posts without snagging

Part#	Cable Size	Length
3221	1/8"	4-1/2"
3222	3/16"	4-1/2"
3223	1/4"	4-1/2"
*3221-CURVE	1/8"	4" curved

*Curved Lacing Needle used with DesignRail® single corner posts



CABLE CUTTERS

- For shearing stainless steel cables

Part#	Cable Size	Length
2972-PKG	Up to 1/8"	7-1/2"
2971	Up to 1/4"	13"



⚠ WARNING: These cutters and crimper can expose you to Di(2-ethylhexyl)phthalate (DEHP) which has been determined by the State of California to cause cancer and birth defects or other reproductive harm. For more information go to www.P65Warnings.ca.gov

CABLECRIMP CRIMPER

- For attaching 1/8-in and 3/16-in CableCrimp style hand swage fittings in the field

Part#	Description
3742	Double-cavity x 20" long





Meta Designs



Pearl's Mobile Welding & Fab



STAINLESS STEEL CLEANER & PROTECTANT KIT



- Feeney SteelRenewal™ & SteelProtect™ make it easy to clean and maintain all stainless steel surfaces, fittings, and cables
- Kit includes a bottle of SteelRenewal™ & SteelProtect™, applicator brush, sponge, and protective gloves
- Non-toxic, biodegradable

Part#	Description
5064-PKG	Feeney SteelRenewal™ + Feeney SteelProtect™ (100 ml Bottle, each)

⚠ **WARNING:** SteelRenewal™ can expose you to propylene glycol which has been determined by the State of California to cause cancer. For more information go to www.P65Warnings.ca.gov

CABLERAIL ACCESSORY KIT



- Handy kit for installing and maintaining CableRail cables and fittings
- Kit includes Stainless Steel Cleaner & Protectant Kit, Lacing Needle, Quick-Connect® Release Tool

Part#	For Cable Size
CR-KIT	1/8", includes Multi-Tool
CR-KIT 3-16	3/16"

TENSION GAUGE



- Easy to use tool for checking cable tension
- | Part# | For Cable Sizes |
|----------|----------------------------|
| 6004-PKG | 1/8", 3/16", & 1/4" cables |

CABLERAIL TENSIONING TOOL



- Easy to use tool for tightening cables
 - Works on Quick-Connect® Inset fitting to efficiently pull cable through the fittings and maximize cable tension on long runs
- | Part# | For Cable Sizes |
|----------|----------------------------------|
| 6005-PKG | 1/8" |
| 5071 | Adapter for 3/16" and 1/4" cable |

Custom Cable Assemblies Are Easy To Install

Railing infill is the most common use of custom cable assemblies, and the installation steps outlined below are directed to that usage. However, the basic concepts would apply to both fence and trellis projects as well. For more comprehensive installation information, please visit our website www.feeneyinc.com, or call our toll-free line at 1-800-888-2418 for assistance.

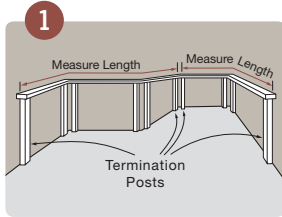

1 Select your cable and fittings, and construct your railing frame accordingly. Determine which posts or walls will be used for terminating the cable assemblies. See railing frame recommendations on pages 38 & 39.

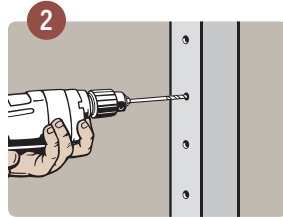

2 Mark and drill holes in all posts. Hole sizes will vary depending on the size and style of cable fittings used.

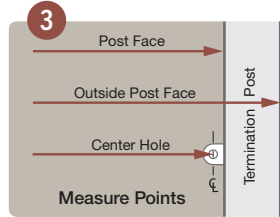

3 Determine the lengths of your cable assemblies by measuring the distance between the “measure points” on the termination posts. The “measure point” depends on the style of fittings used (see Fitting Measure Point chart below).

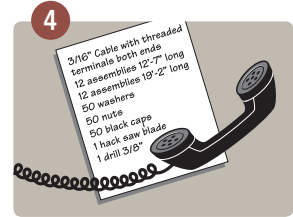

4 Call to ask questions and to order cable assemblies and accessories: toll-free 1-800-888-2418 or 1-510-893-9473.

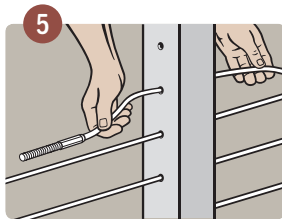

5 Lace the cable assemblies through your intermediate posts and attach the end fittings to the termination posts. See drawings on page 37 for details on angled stair terminations.

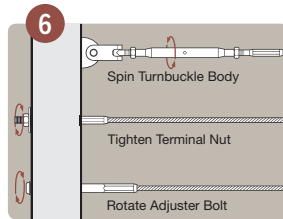

6 Tighten the cables using the Tension Adjustment Fittings. Depending on the fittings used, trim any excess material and apply caps to finish the ends. A tension gauge may be used to check uniform tension.

Measure Point for Each Type of Fitting

Fitting Type	Post Face	Outside Post Face	Center Hole
All Surface Mount style turnbuckles	X		
Surface Mounts	X		
Lock Toggles	X		
Quick-Connect® Pivot & Lag fittings	X		
Quick-Connect® Expansion Anchors	X		
Threaded Terminals		X	
Internal Thread Adjusters		X	
All Cap End style turnbuckles		X	
All Ball End style turnbuckles		X	
Cap Ends		X	
Ball Ends		X	
Quick-Connect® Inset		X	
Button Heads		X	
All Jaw style turnbuckles			X
Jaw Ends			X

CONSTRUCTION CHECKLIST

- Space cables no more than 3-in apart
- Space posts/verticals no more than 3-ft apart
- Observe minimum end/corner post sizes shown on page 38
- Securely fasten all posts and cap rails
- Carefully plan all termination and corner posts for proper clearance, positioning, and maximum cable run lengths
- To ensure proper tensioning, straight runs of cable (no turns, dips, or rises) should include a Tension Adjustment Fitting at least every 50-ft
- Runs with bends or corners should have a Tension Adjustment Fitting at least every 40-ft or after every second corner bend (whichever distance is shorter)

IMPORTANT NOTES

- Since building codes vary by state, county, and city, our recommendations may not comply with code requirements in all areas. Always consult with your local building department before starting your project.
- CableRail cable assemblies and fittings are designed for use on railings, fences, and trellises only. They should never be used for lifting, hanging, or high load applications.



Typical Angled Terminations

Note: These attachment details also apply to the corresponding turnbuckles and tensioners.

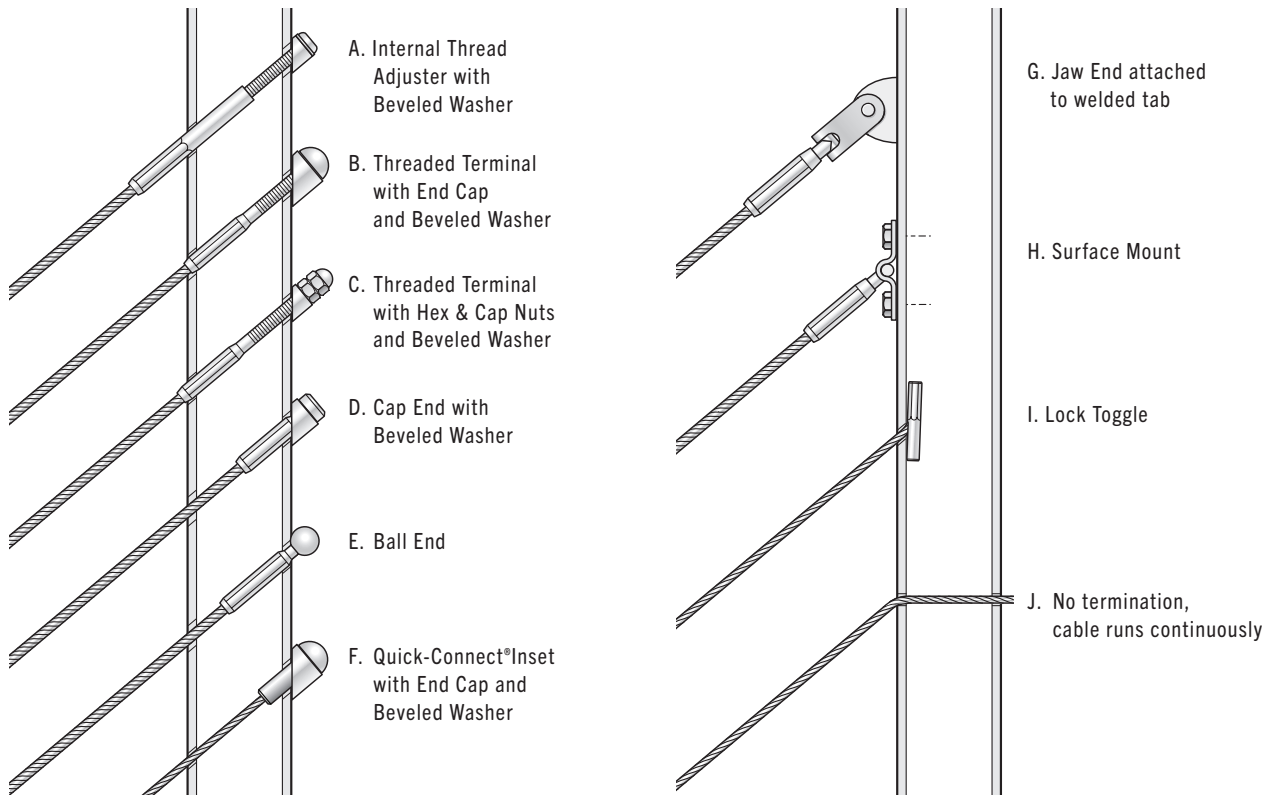

A FEW WORDS ABOUT STAINLESS STEEL

The protective chromium oxide film on the surface of stainless steel gives it superior corrosion resistance. Properly maintained stainless steel provides excellent luster, strength, and durability. In most applications, stainless steel will not rust or stain even after years of service, but it is NOT rust or stain proof. When stainless comes in contact with chloride salts, sulfides, or other rusting metals, it can discolor or even rust and corrode. With proper care and maintenance, however, stainless steel can remain beautiful and functional for years to come, even when it is exposed to marine environments, polluted surroundings, salted highways, or other corrosive elements. For complete care and maintenance instructions, please visit our website www.feeneyinc.com

Frames need to support the tension of properly installed cables

They need to be designed and built strong enough to support a load of at least 300 lbs for each cable. Frames can also be designed to use cables more efficiently, thereby reducing the total quantity of cable assemblies needed and the overall cost. Below are some basic guidelines to help you prepare railing frames for cable infill. We also encourage you to carefully review all of the cable and fitting detail pages and installation pages, and if you have any questions, please call us at 1-800-888-2418 for assistance.



Minimum Sizes for All Corner and End Posts

All other posts should be sized as required for top rail support strength or for code.



4X4 WOOD

3-1/2" wide & thick

Note: softer woods may require larger post sizes, especially with 42-in high railings



FLAT BAR

2" wide, 1" thick



ANGLE IRON

2" wide, 1/2" thick



EXTRA STRONG PIPE

1-1/2" I.D., 1-7/8" O.D.



SQUARE TUBE

2" wide, 1/4" wall

The Basic Frame Design

Spacing From Walls

Unless using Surface Mount or Jaw type cable fittings, always set end posts 3 to 4-in away from the wall face to allow access for attaching cable end fittings through the post.

Top Rail

Always include a strong, rigid top rail that is securely fastened to all posts. Top rail size is based on load strength needs and local code requirements. Set railing height per local code.

Cable Spacing

Maximum 3-in apart.

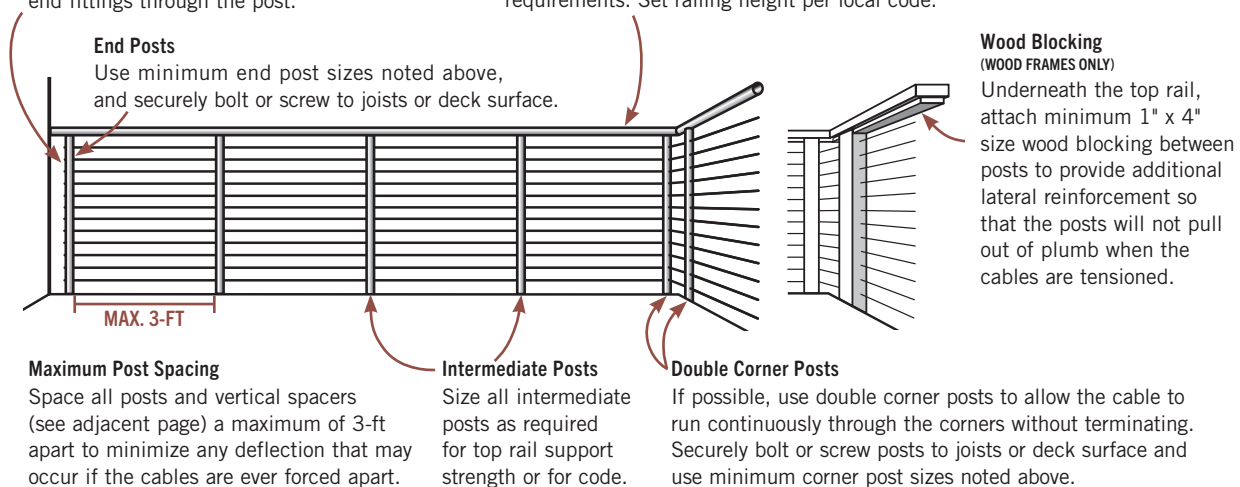



Ellerbe Becket



Allentown Homes

And Some Other Options

Vertical Spacers (OPTIONAL)

Slender spacers may be used instead of larger intermediate posts to achieve a more open railing design. These are non-structural members and are only intended to maintain cable spacing and minimize deflection. Examples are 2" x 2" wood strips, 1" metal tubing, or 1/4" flat bar. Attach to the top rail and either the foot rail, deck surface, or joists.

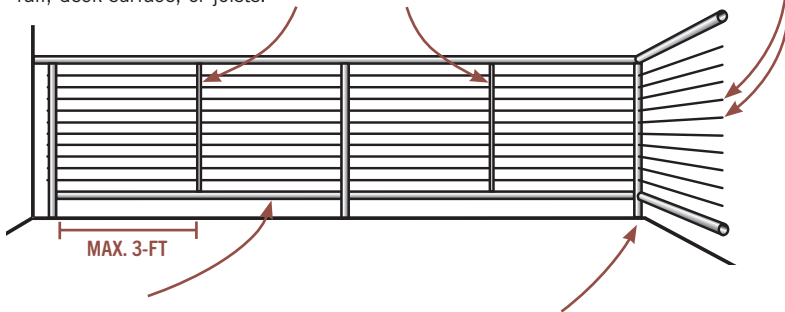

Bottom Rails (OPTIONAL)

Bottom rails should be spaced no more than 4-in above the deck surface, or as required by local code, and should be sized as needed for support strength and design appearance.

Single Corner Post (OPTIONAL)

In most cases with single corner posts, cables must be terminated. Exceptions are angle iron posts or tubular metal posts (when using hand swage fittings). When terminating on a single corner post, be sure to offset the drill holes at least 1/2" to allow internal clearance for the cable fittings. Use minimum end post sizes noted on page 38, and securely bolt or screw to joists or deck surface.

10 YEAR LIMITED WARRANTY

Feeney, Inc. warrants that all CableRail stainless steel cable and connectors shall be free from defects in material and workmanship under normal use, conditions, installation, and maintenance in accordance with product specifications for ten (10) years from date of purchase. The complete warranty is available on our website www.feeneyinc.com

HOW TO ORDER CABLERAIL

- 1) **Carefully Review:** Read all of the product information provided in this catalog and on our website www.feeneyinc.com. If you have questions, please call our sales department for assistance, 1-800-888-2418.
- 2) **Select Cable:** Decide on the cable size and construction.
- 3) **Select Fittings:** Select the style and type (Machine or CableCrimp or QuickConnect®). Remember, each assembly must include at least one Tension Adjustment Fitting.
- 4) **Calculate Assembly Lengths:** See the installation steps and "measure point" chart on page 36.
- 5) **Determine Quantities:** Quantities depend on the railing design. Remember, space cables no more than 3-in apart.
- 6) **Check Accessories:** Make sure you have all the necessary nuts, screws, caps, washers, crimpers, cutters, etc.
- 7) **Place the Order:** Visit an authorized Feeney dealer to purchase the items. To locate a dealer in your area, click the dealer locator at www.feeneyinc.com or give us a call.

FREE: 1-800-888-2418

PH: 1-510-893-9473

FAX: 1-510-788-6041

SALES@FEENEYINC.COM

WWW.FEENEYINC.COM

DesignRail®

Searching for a complete railing? Look no further.

DesignRail® Aluminum Railings combine the durability of aluminum with innovative design details to ensure lasting beauty, and structural integrity while drastically reducing long term maintenance expenses. All rails and stanchions are made from high-strength 6000-series aluminum extrusions that can be cut and assembled on site using pre-engineered components that snap and screw together. DesignRail® Aluminum Railings are easily adaptable to any project: interior or exterior, commercial or residential. Simply choose the style options that are best for your project to custom design your railing.

- For railings, fences, privacy panels, barriers
- Available in a variety of top rail styles, as well as cable, glass, and picket infill options
- Durable powder-coated finishes offer superior color retention, impact resistance, and weather protection
- Available in an assortment of colors that meet rigorous AAMA-2604 coating specifications
- Low maintenance with long use cycle: no rusting, cracking, peeling, or repainting
- Easy field assembly with components that snap and screw together: no welding, grinding or special finishing
- Lightweight materials reduce shipping costs, save fuel, and are easier to handle on the job
- Accessory items include ADA compliant handrails, custom gates, and low-voltage LED lights
- Detail drawings and 3-part specifications available at www.feeneyinc.com
- Toll-free design assistance and technical support line, 1-800-888-2418
- Product contains recycled materials 

See our new DesignRail® Kits on pages 46-47





Posts

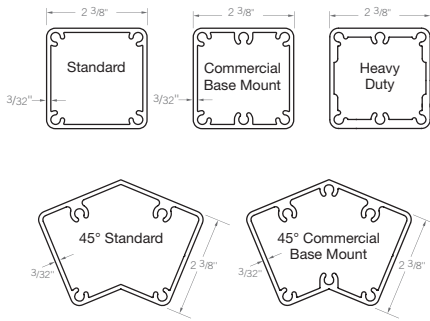

Posts are made from 2³/₈-in square tube extrusions in three different distinct cross-sectional profiles: Standard, Commercial Base Mount, and Heavy Duty. Each is specially engineered to provide optimal structural strength and design performance for specific usage and load conditions. Our customer service team will determine which posts are required based on the type of project and the railing design options selected.

Posts for horizontal railings come pre-cut for 36-in, 38-in, and 42-in railing heights. Stair or custom posts must be cut to height in the field and extrusions can be ordered in 10-ft or 20-ft lengths for that purpose. When using horizontal cable infill, all posts, including stair posts, are available pre-drilled for the cables (learn more on page 48).

We also offer a 45° corner post that provides the option of a single post construction at 45° corners. It is available in Standard and Commercial Base Mount profiles. These posts come pre-cut and pre-drilled (except when used on stairs or ramps).

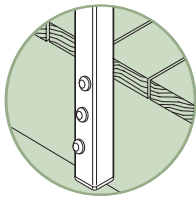

FASCIA MOUNT

- For side mounting to fascia boards, joists, or walls
- Posts come with pre-drilled bolt holes

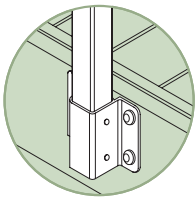

FASCIA BRACKET MOUNT

- For side mounting to fascia or rim joists when decking or nosing trim extends beyond the edge of the fascia board
- Posts are attached using metal brackets that have a 1¹/₄-in standoff
- Railing may require a bottom rail when using this mounting method

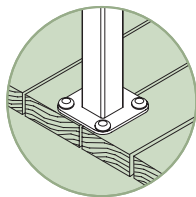

SURFACE (BASE) MOUNT

- For top mounting to deck, patio, floor, or stair tread surfaces
- ³/₈-in thick by 5-in square base plate for square posts and ³/₈-in thick with a 1⁵/₁₆-in contour reveal for 45° posts
- Plates come pre-attached to posts

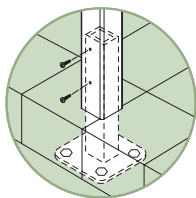

STANCHION MOUNT

- For mounting with stone or tile covered concrete slabs or on roof decks where penetration of waterproof roofing membranes must be minimized
- Short stanchions are attached to the structural members prior to pouring the slab or laying the roof membrane. Railing posts are then sleeved over the protruding stanchion ends and secured with screws
- Stanchions available in steel, aluminum, or stainless steel (Material used will affect post installation and spacing)
- Typically 12-in tall but can be custom sized and supplied with or without base plates

**ALSO SEE OUR ITEMS
ON PAGE 48**

- Pre-Drilled Stair Posts & Pickets
- Single Corner Posts
- Decorative Post Base Plate Covers

Frame Colors

- Durable powder-coated finishes are available in 14 standard colors and over 200 custom colors
- Finishes meet rigorous AAMA-2604 coating specifications for superior color retention, impact resistance, and weather protection

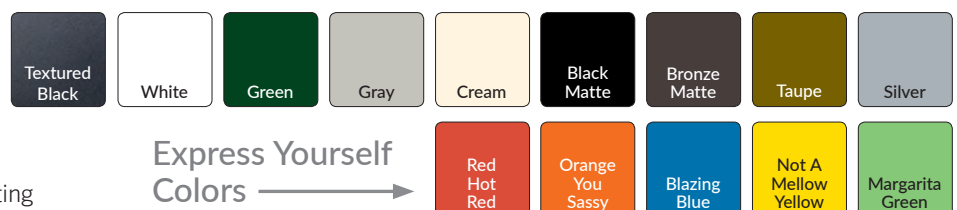

Express Yourself
Colors →

The standard color samples shown represent approximate color only.

Top Rails

Top rails come in 6 styles and are sold in 10-ft and 20-ft lengths that can be trimmed to size in the field. Series 150 Graspable Top Rails are used on stairs to provide a graspable top rail. Series 150 and Series 100 Top Rails are attached to the faces of the posts using Rail Connecting Brackets (RCBs). Series 200, 300, 350, and 450 Top Rails rest on the tops of the posts and are secured with stainless steel screws. Applied Continuous Handrails with extensions and returns (see page 48) are available as an accessory item to meet ADA and code handrail requirements.

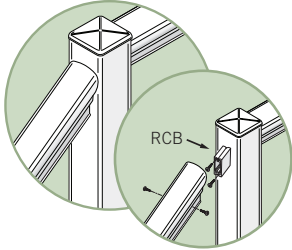

GRASPABLE TOP RAIL (Series 150)

- 2-in wide top rail with easy-to-grasp shape
- Can be used for both stair and horizontal railings
- Meets residential code requirements for stair handrail sizing. Requires an Applied Handrail (page 48) when used on stairs in commercial settings

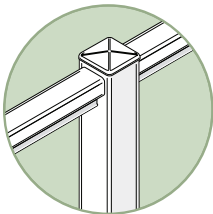
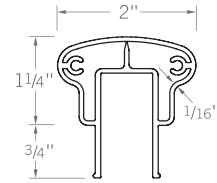

SQUARE TOP RAIL (Series 100)

- 2-in wide square-shaped top rail
- The narrow width allows it to be installed between posts (using RCBs) instead of on top of posts, creating a newel-post-style railing with posts rising above the top rail
- Requires an Applied Handrail when used on stairs

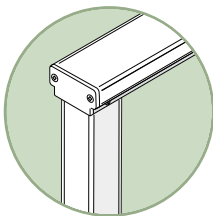
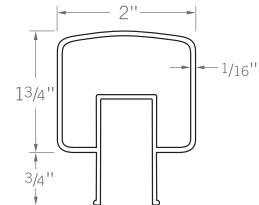

RECTANGULAR TOP RAIL (Series 200)

- 3 1/2-in wide rectangular top rail
- The flat surface is a convenient perch for your favorite beverage as you relax and gaze at the view
- Requires an Applied Handrail when used on stairs

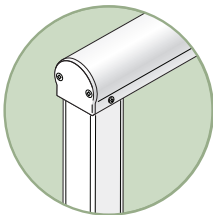
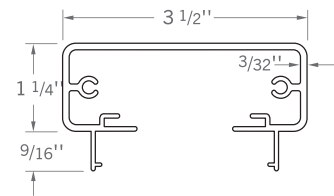

ROUND TOP RAIL (Series 300)

- 1 1/2-in radius top rail
- The smooth rounded shape offers a more contemporary accent to those less traditional architectural designs
- Requires an Applied Handrail when used on stairs

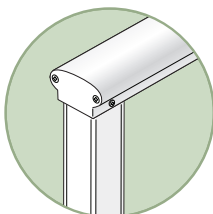
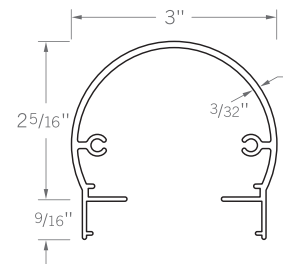

ELLIPTICAL TOP RAIL (Series 350)

- 3 1/2-in wide elliptical top rail
- The sleek, stylish design offers another option for those who prefer a less angular top rail appearance
- Requires an Applied Handrail when used on stairs

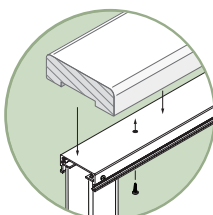
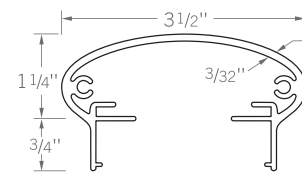

LOW-PROFILE TOP RAIL (Series 450)

- Low-profile top for adding your own wood or composite cap rails
- Cap rails are optional and are not included
- Requires an Applied Handrail when used on stairs

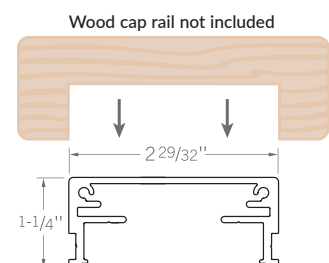

Infill

The basic infill options are illustrated below. Also see www.feeneyinc.com/Create-your-Own for our new panel infill options including stainless steel wire mesh panels, powder-coated laser cut aluminum panels and resin panels with imbedded organic materials such as bamboo, leaves and grasses.

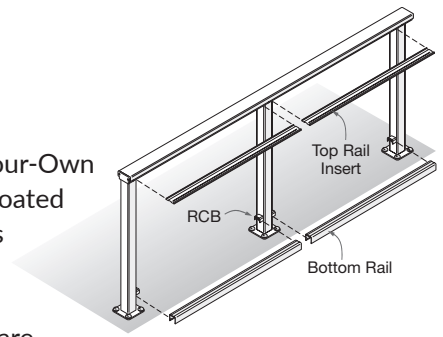

All infill options require a Top Rail Insert and a horizontal Bottom Rail (Bottom Rails are optional for 36-in and 38-in high frames using horizontal cable infill). These support the railing infill and help reinforce the frame structure. Bottom Rails connect to the posts using Rail Connecting Brackets (RCBs), and Top Rail Inserts snap into the underside of the Top Rails. Each infill type has a specific corresponding Bottom Rail and Top Rail Insert design. Available in 10-ft and 20-ft lengths that can be cut to size in the field.

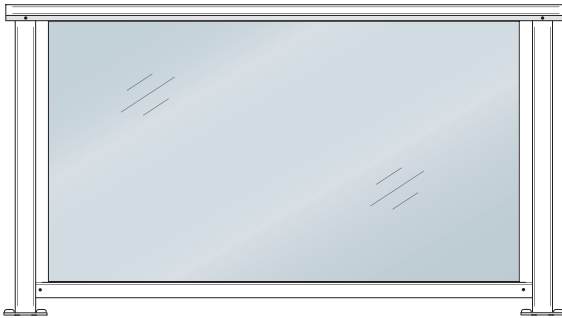

TEMPERED GLASS

- Clear or custom tinted panels that are easily inserted into vinyl lined slots in the Top Rail Insert and Bottom Rail
- No special mounting hardware needed
- Glass panels are shipped cut to size after the frames are constructed and final opening measurements are submitted

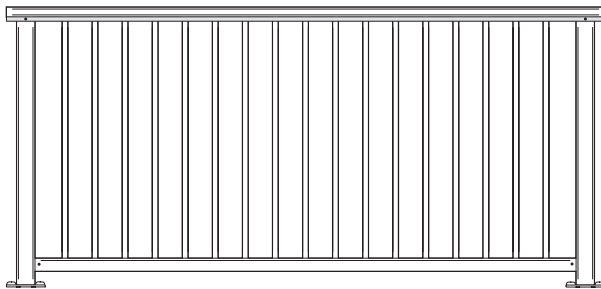

VERTICAL PICKETS

- 3/4-in square aluminum pickets
- Powder-coated to match the frame color
- Available in pre-assembled panels that can be trimmed to length in the field

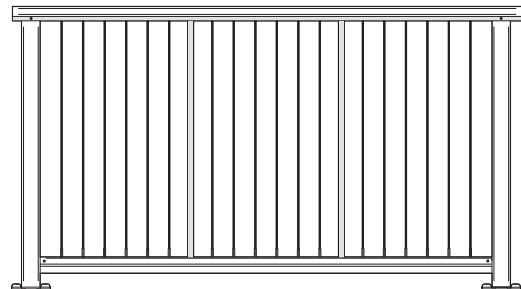

VERTICAL CABLES

- 1/8-in diameter 316-grade stainless steel cables come prefabricated to size with all of the attachment fittings, ready to install
- Two vertical intermediate pickets are spaced mid-span to maximize frame rigidity

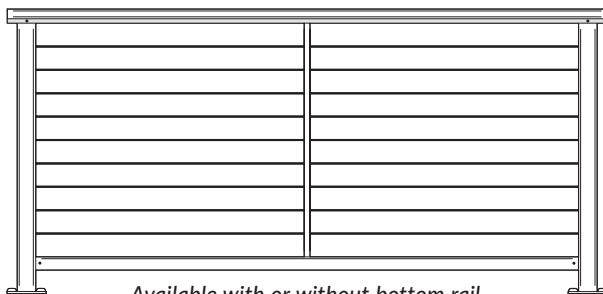

Available with or without bottom rail.

HORIZONTAL CABLES

- 316-grade stainless steel CableRail kits (pgs 10 & 16) or Conceal Kits (pg 16) include all of the attachment fittings and come pre-fabricated in standard lengths that can be trimmed to exact dimensions in the field
- A vertical intermediate picket is used mid-span to minimize cable deflection
- All posts and pickets come pre-drilled, ready for cable installation

Feeney Lighting

Whether it's entertaining, playing, or just relaxing, our specially designed LED lighting and components work with our DesignRail® aluminum railings to help you create the perfect ambiance for everything you do. Our 24v lighting is manufactured with high quality weatherproof materials for reliable performance and energy efficient LEDs that are rated for up to 50,000 hours and have a high color rendering index (80+) for truer colors.



RAIL LIGHTING

- Easy-to-Install lights that integrate into the top rail or bottom rail to provide beautiful under-rail lighting. Weatherproof lighting strips have a high-bond, waterproof adhesive for easy installation, and our exclusive Feeney polycarbonate lens diffuses light evenly across the railing.

POST ACCENT LIGHT

- This decorative aluminum sconce has a durable powder-coated finish and attaches to the post face to create a beautiful down light; great for stair railing accents. The sconce can be powder coated to your DesignRail® railing color.

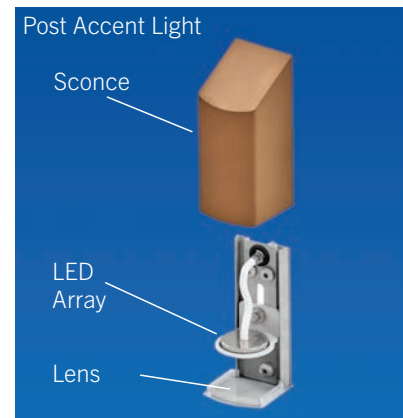
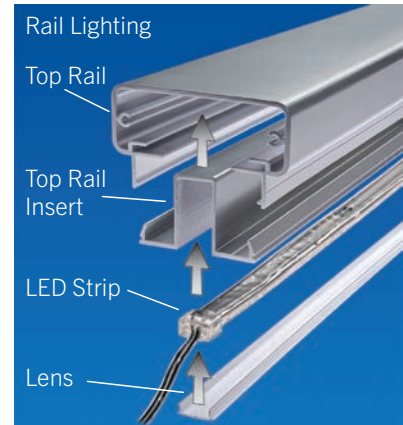

POWER KITS

- Outdoor rated, 24 volt DC dimmable drivers in 40 watt 60 watt, and 96 watt (all driver kits sold separately).

DesignRail® Kits

CREATING YOUR RAILING IS EASY!

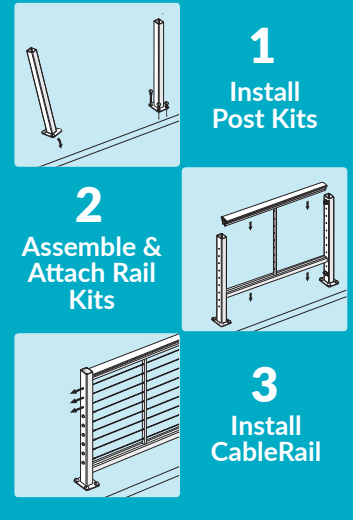

Modular Aluminum Railing System

Create beautiful railings inside and out with DesignRail® Kits and CableRail stainless steel cable infill. All our rail and post kits feature 6000 series aluminum and AAMA-2604 powder coated finishes for long lasting beauty and durability, and are available for 36-in and 42-in high railings. Your railing system will require specific quantities and types of kits and parts depending on the configuration of your project.

RAIL KITS

- LR** Level Rail Kit
- SR** Stair Rail Kit

LEVEL POST KITS

- IN** Intermediate Post Kit
- TT** Threaded Terminal Post Kit
- QC** Quick-Connect® Post Kit
- SC** Single Corner Post Kit
- NR** Newel Termination Post Kit (Right)
- NL** Newel Termination Post Kit (Left)
- NP** Newel Passthrough Post Kit

STAIR POST KITS

- INS** Intermediate Stair Post Kit
- TTS** Threaded Terminal Stair Post Kit
- QCS** Quick-Connect® Stair Post Kit

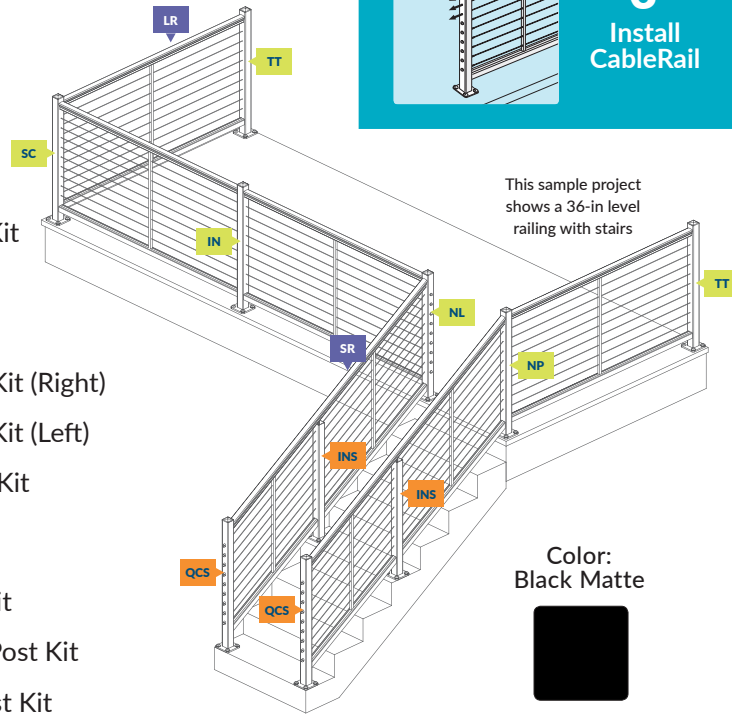

Rail Kits

Rail Kits contain the rails that run between the posts. Each kit includes a 6-ft top and bottom rail, a pre-drilled intermediate picket, and all necessary attachment hardware. Top and bottom rails can be trimmed to exact length and stair slope in the field. Use Rail Cut Kits if cutting a single Rail Kit for use in multiple smaller sections. Rail Kits can be used with DesignRail® Post Kits or between your own wood posts.

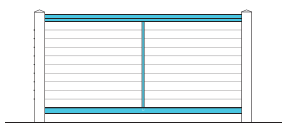
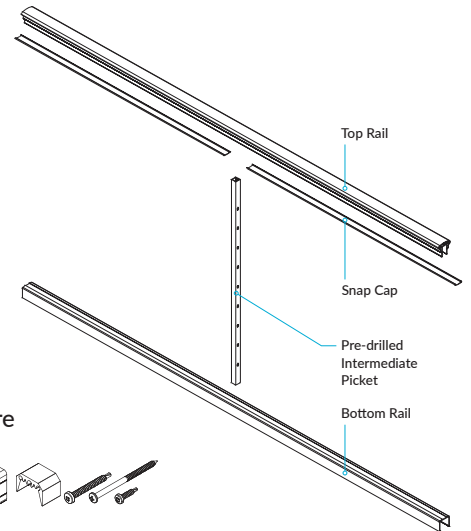

LR

LEVEL RAIL KIT

36-in Black (#7724 BLK-PKG)
42-in Black (#7609 BLK-PKG)

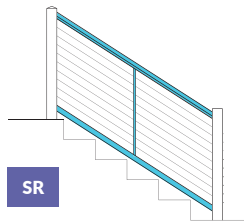

SR

STAIR RAIL KIT

36-in Black (#7610 BLK-PKG)

Attachment Hardware

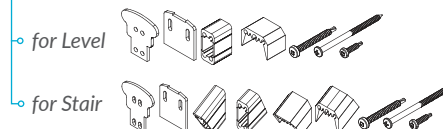

Post Kits

Each Post Kit includes a post with a pre-attached base plate, a post cap, and mounting screws with caps. All posts come pre-drilled for the cable fittings or for cables to pass through, and can accommodate isolation bushings when required. Stair posts are pre-drilled at an angle to accommodate a stair slope of between 29 and 34 degrees. Level post kits are available for railings in two heights: 36-in with 9 cable holes, or 42-in with 11 cable holes. Stair post kits are available for 36-in stair railings. Isolation bushings are recommended for installations in harsher climates, such as areas near salt water.

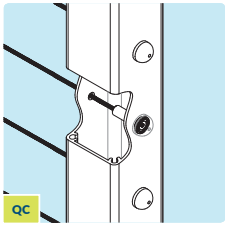
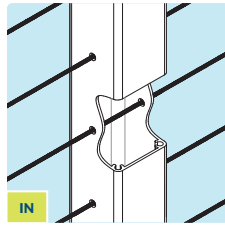
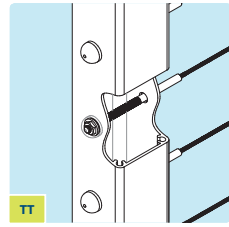

LEVEL POSTS

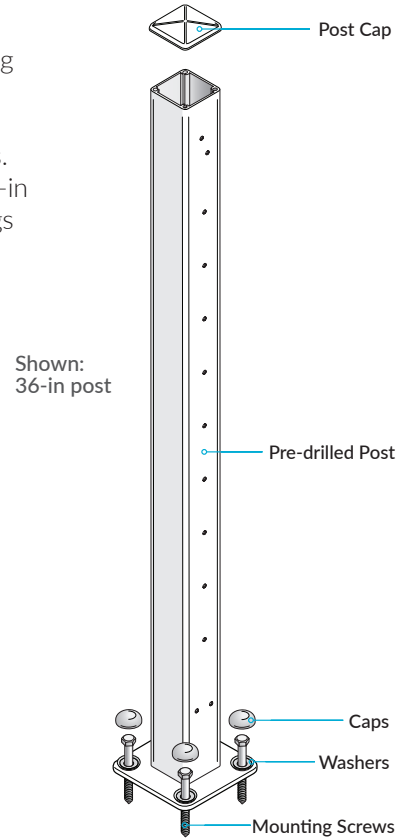
 <p>QUICK-CONNECT® END POST KIT</p> <p>Pre-drilled for CableRail Quick-Connect® end fittings.</p> <p>36-in Black (#7613 BLK-PKG) 42-in Black (#7618 BLK-PKG)</p>	 <p>INTERMEDIATE POST KIT</p> <p>Pre-drilled for cable to pass through.</p> <p>36-in Black (#7611 BLK-PKG) 42-in Black (#7616 BLK-PKG)</p>	 <p>THREADED TERMINAL END POST KIT</p> <p>Pre-drilled for CableRail Threaded Terminal end fittings.</p> <p>36-in Black (#7612 BLK-PKG) 42-in Black (#7617 BLK-PKG)</p>
--	--	--

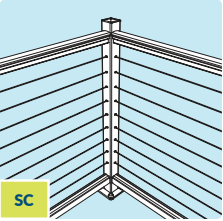
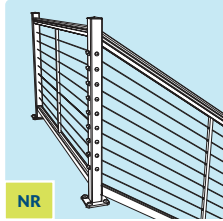

DESIGN NOTE:
Use Feeney Base Plate Covers (sold separately) for a more finished look. See page 48 for more information.

LEVEL POSTS

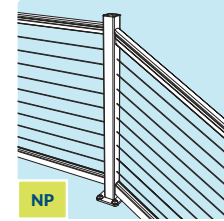
 <p>SC</p> <p>SINGLE CORNER POST KIT</p> <p>Specially designed for use at corners. Pre-drilled for CableRail to run continuously through the post.</p> <p>36-in Black (#7624 BLK-PKG) 42-in Black (#7720 BLK-PKG)</p>	 <p>NR</p> <p>NEWEL TERMINATION POST KIT RIGHT</p> <p>Designed for level-to-stair railing transitions that have a right 90° turn from the stairs. Use Quick-Connect® fitting in level holes and Threaded Terminal fitting in angled holes.</p> <p>36-in Black (#7598 BLK-PKG) 42-in Black (#7721 BLK-PKG)</p>	 <p>NL</p> <p>NEWEL TERMINATION POST KIT LEFT</p> <p>Designed for level-to-stair railing transitions that have a left 90° turn from the stairs. Use Quick-Connect® fitting in level holes and Threaded Terminal fitting in angled holes.</p> <p>36-in Black (#7599 BLK-PKG) 42-in Black (#7722 BLK-PKG)</p>	 <p>NP</p> <p>NEWEL PASSTHROUGH POST KIT</p> <p>Designed for level-to-stair railing transitions where cables continue through.</p> <p>36-in Black (#7600 BLK-PKG) 42-in Black (#7723 BLK-PKG)</p>
--	---	---	--

STAIR POSTS

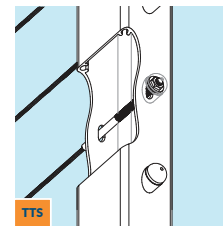
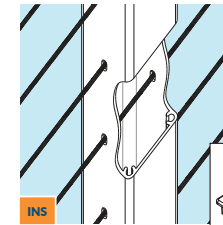
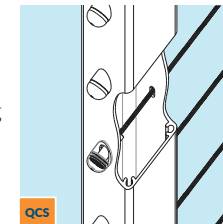
 <p>TTS</p> <p>THREADED TERMINAL STAIR END POST KIT</p> <p>Pre-drilled for CableRail Threaded Terminal end fittings.</p> <p>36-in Black (#7614 BLK-PKG)</p>	
 <p>INS</p> <p>INTERMEDIATE STAIR POST KIT</p> <p>Pre-drilled for cable to pass through.</p> <p>36-in Black (#7619 BLK-PKG)</p> <p>Includes a Post Stair Adapter for connecting two Stair Rail Kits. Adapter attaches to top of posts.</p>	
 <p>QCS</p> <p>QUICK-CONNECT® STAIR END POST KIT</p> <p>Pre-drilled for CableRail Quick-Connect® end fittings.</p> <p>36-in Black (#7615 BLK-PKG)</p>	

CableRail Kits (6200-series):

1/8-in diameter stainless steel cable kits are easy to install and maintain with your aluminum railing kits. Available in a variety of lengths to accommodate any job. See pages 10 & 11 for complete CableRail Kit information.

Tools & Accessories:

See website for information on additional items to help install and detail the perfect railing solution. Accessories include decorative base plate covers, curved cable lacing needles, touch-up paint, rail cut kits, isolation pads and bushings, and more.

Additional Items



PRE-DRILLED STAIR POSTS & PICKETS

Stair posts & pickets that come pre-drilled for 1/8-in CableRail cables; no more drilling angled holes on site.

- Saves installation time
- Offered in 3 angle ranges: (23°- 28°) (29°- 34°) (35°- 39°)
- Specially designed slender slotted holes optimized for function and aesthetics
- Can be field trimmed to desired railing height
- Available for all post mounting styles
- Beveled Washers available to match the 3 angle ranges
- Isolation Bushings available for salt air and harsh environments



SINGLE CORNER POSTS

Single post design that allows 1/8-in CableRail cables to run continuously through a corner.

- Fewer Posts, More View!
- Faster to install, more economical, and visually attractive
- For 36-in, 38-in, and 42-in railing heights
- Available for all post mounting styles except Stanchion Mount
- Use Curved Cable Lacing Needle (#3221-curve) to install cable
- Use Isolation Bushing (#1121) for salt air and harsh environments



BASE PLATE COVERS

- Adds a finished detail to base mounted posts
- Powder coated to match the frame color
- Easy assembly with 2-piece, snap-together, fastener-free design (use of silicone adhesive recommended)
- Fits all DesignRail 2 3/8-in square post profiles

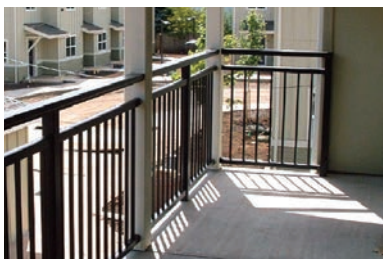

INTERMEDIATE HORIZONTAL RAILS

- Used with picket, glass, and horizontal infill for creating railing designs with partial height infill
- Sold in 10-ft and 20-ft lengths that can be trimmed to size in the field
- Attaches to the post faces using Rail Connecting Brackets (RCBs)

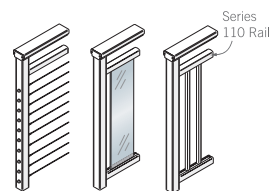

APPLIED CONTINUOUS HANDRAILS

- 1 1/2-in diameter aluminum handrails to meet stair railing code requirements
- ADA compliant extensions and returns
- Custom bent and fabricated, ready for installation

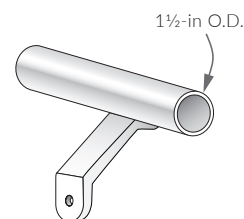

GATES

- Custom fabricated to size
- Available for all railing styles and infill types



Adjustable Gate Hinges



Gate Latch



Cane-Bolt

GATE HARDWARE ACCESSORIES

- Gate latch, cane bolt, and adjustable gate hinge accessories
- Made from UV stabilized, super-strong engineered polymer and stainless steel
- Designed for exceptional durability and lasting, reliable performance
- Easy installation and adjustment with smooth working action
- Key-lockable security features

ISOLATION BUSHINGS & PADS

- Bushings eliminate direct contact of dissimilar metals to minimize electrolysis when attaching cables and fittings to metal posts in areas with salt air or similar harsh elements
- Pads protect posts, pickets, and base plates from chemical corrosion caused by contact with concrete or pressure treated wood surfaces
- Bushings made from engineered polymers that are highly resistant to abrasion and UV degradation
- Pads made from high-density neoprene



4X4 POST CAPS

- For finishing tops of 4x4 wood posts
- Made from powder coated aluminum
- Available in black matte, bronze matte, and white



Construct Your Railing Frame in 5 Basic Steps

DesignRail® Aluminum Railings are designed to quickly screw and snap together on site with only a few basic tools. Detailed installation instructions are included with each order and are also available on our website www.feeneyinc.com

1 Install Posts

Install the posts starting with the end and corner posts, continuing on to the intermediate posts.

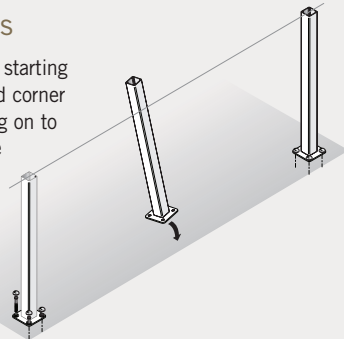

2 Attach Top Rails

Measure and cut the Top Rails and attach to posts using screws.

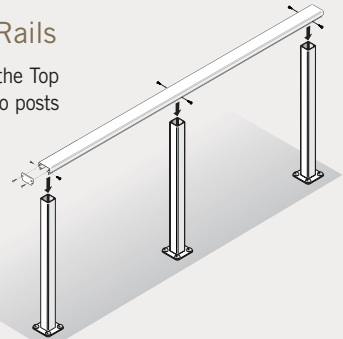

3 Attach RCBs

If using Bottom Rails, screw the Rail Connecting Brackets (RCBs) to the posts for attaching the Bottom Rails.

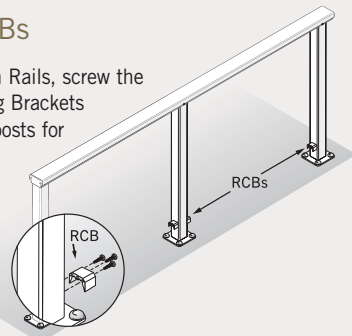

4 Prepare Infill Supports

Measure and cut Top Rail Inserts and Bottom Rails for each panel section.

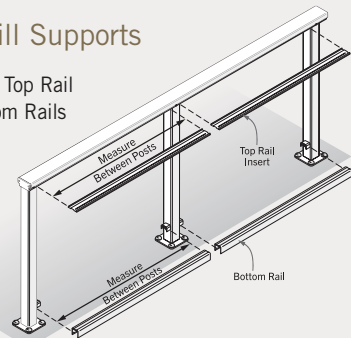

5a Picket Infill Option

Trim the pre-fabricated picket panels to length, then lift the complete panel into position on the railing frame and screw in place.

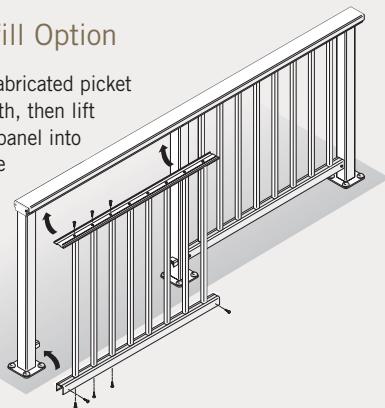

5b Glass Infill Option

Attach Top Rail Insert and Bottom Rail to railing frame and insert vinyl liners. Lift the pre-cut panels into the Top Rail Insert, then lower into final position in Bottom Rail slot.

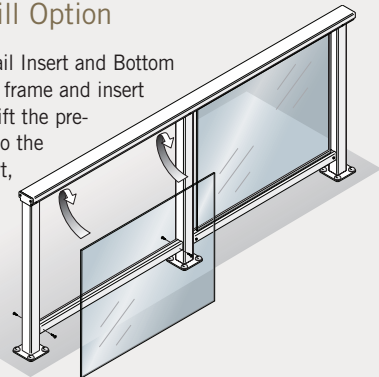

5c Horizontal Cable Infill Option

Screw intermediate pickets to Top Rail Insert and Bottom Rail (if using Bottom Rail), then lift into position on frame and screw in place. Lace cables through pre-drilled holes in posts and pickets, then tighten and trim.

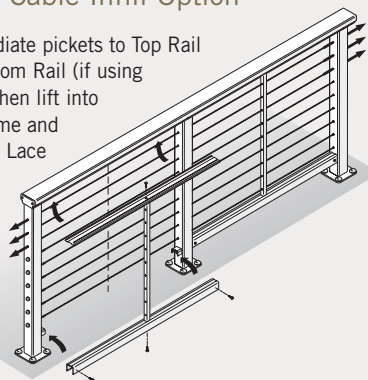

5d Vertical Cable Infill Option

Screw intermediate pickets to Top Rail Insert and Bottom Rail and loosely attach cables. Lift entire panel into position on railing frame and screw in place. Tighten nuts at bottom for final cable tension.

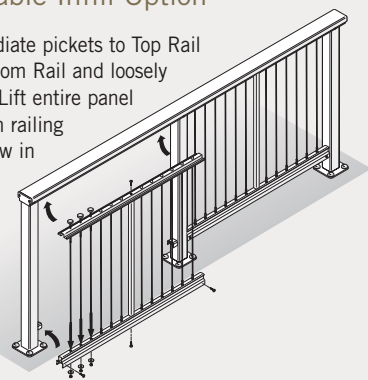

HOW TO ORDER DESIGNRAIL®

- 1) Carefully Review:** Read all of the product information provided in this catalog and on our website www.feeneyinc.com. If you have questions, please call our sales department for assistance, 1-800-888-2418.
- 2) Determine Frame Height:** 36-in, 38-in, or 42-in.
- 3) Decide Post Mountings:** Fascia, surface (base), fascia bracket, or stanchion mount.
- 4) Select Top Rail:** Series 100, 200, 300, 350, 450, or Series 150 for stairs.
- 5) Choose Infill:** Aluminum picket, glass, horizontal cable, vertical cable, or our new infill panels.
- 6) Pick Frame Color:** Choose from the 14 standard colors or call for custom colors.
- 7) Review Other Items:** Will you need stair handrails, low voltage lights, or gates?
- 8) Confirm Details & Prices:** All railing projects are unique. Call us at 1-800-888-2418, and our staff will assist you in confirming a list of the parts needed for your project.
- 9) Place Your Order:** Visit an authorized Feeney® dealer to place your order. To locate a dealer in your area, click the dealer locator at www.feeneyinc.com or give us a call.

FREE: 1-800-888-2418

PH: 1-510-893-9473

FAX: 1-510-788-6041

SALES@FEENEYINC.COM

WWW.FEENEYINC.COM

Note On Packaging

All DesignRail® aluminum frames and components are carefully packaged to ensure that products arrive damage-free. Top Rails, Bottom Rails, and Top Rail Inserts are shipped in special 11-ft and 21-ft boxes, and all posts and hardware items are boxed, wrapped, and shipped on standard pallets.

IMPORTANT NOTE

Building codes vary by state, county, and city, so be sure to consult with your local building department before starting your project.



Art Sachs Photography

10 YEAR LIMITED WARRANTY

Feeney, Inc. warrants that all DesignRail® Aluminum Component Railings adhere to AAMA-2604 coating specification guidelines and will not crack, flake, blister, or peel under normal use, conditions, installation, and maintenance in accordance with product specifications for ten (10) years from date of purchase. In addition, Feeney warrants that the stainless steel cable and connectors shall be free from defects in material and workmanship under normal use, conditions, installation, and maintenance in accordance with product specifications for ten (10) years from date of purchase. The complete warranty is available on our website: www.feeneyinc.com.

Architectural Rods

Stainless Steel Rod Assemblies Offer Strength, Versatility, & Beauty

Feeney offers a comprehensive range of stainless rods and fittings manufactured from the highest specification materials. Feeney rod assemblies are an attractive, high-strength, low-maintenance alternative to traditional steel rod and wire rope rigging systems, and they have the added benefit of being able to support loads in both tension and compression conditions. All assemblies are made to order, ready to install and can be used in a variety of structural and decorative applications from glass curtain wall and door canopy supports, to guardrail balusters and trellis infill grids.

- Available in $\frac{5}{16}$ -in to 1-in diameter sizes to meet a wide range of design applications
- Low-maintenance, weather-tough 316-grade stainless steel with a satin finish
- Tension Fork fittings offer easy adjustment without bulky turnbuckles
- Special Rod Connectors available for assemblies longer than 12 feet
- Variety of decorative and structural applications
- Cold-heading and other specialty rods and components are available as special order
- Easy ordering with most materials in stock and ready for fast turn-around and delivery
- 3-part specifications available at www.feeneyinc.com
- Toll-free design detail and product selection assistance, 1-800-888-2418
- Product contains recycled materials 





Individual Components



Stainless Steel Rods

- Individual rods are custom cut to length (maximum 12-ft) and threaded for each job (diameters to suit UNF threads 5/16-in to 1-in)
- Rod Connectors are used for spans greater than 12-ft
- Milled wrench flats allow tools grip the rod securely with minimal scratching
- Minimum breaking loads are based on the core diameter of the thread
- 316-grade stainless steel with a satin finish

Rod Diameter	Thread UNF	Breaking Load (lbs)	Proof Stress 0.2% (lbs)
5/16"	5/16"	5170	2725
3/8"	3/8"	7943	4186
1/2"	1/2"	14569	7678
5/8"	5/8"	23458	12363
3/4"	3/4"	31000	18083
1"	1"	55103	32144

Rod Connectors

- For linking two rod sections together to extend lengths beyond 12-ft
- Connectors are tapped left-hand (LH) threads on one end and right-hand (RH) threads on the other to ensure that assemblies will not unscrew during tensioning
- Designed to develop the full load of the rods
- Available in sizes to suit UNF threads 5/16-in to 1-in
- 316-grade stainless steel with a satin finish

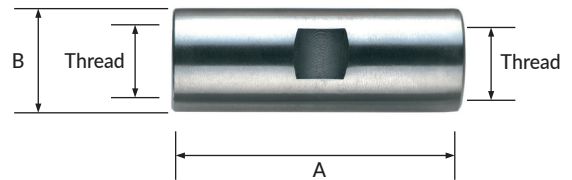

Item #	Thread UNF (LH/RH)	A	B
RC-516	5/16"	1-3/8"	7/16"
RC-38	3/8"	1-5/8"	9/16"
RC-12	1/2"	2-3/16"	3/4"
RC-58	5/8"	2-5/8"	7/8"
RC-34	3/4"	3-1/8"	1-1/8"
RC-100	1"	4-1/8"	1-3/8"

Tension Forks

- Available with left-hand and right-hand UNF threads in 5/16-in to 1-in sizes
- Each fork comes with a locking Conical Nut (CN) and Double Headed Pin
- Using LH and RH threaded Tension Forks on a rod assembly alleviates the need for a turnbuckle and provides the most symmetrical design and economical method of tensioning
- Designed to support the full load of the rods
- 316-grade stainless steel with a satin finish

Item #	Thread UNF	CN	A	B	C	D	PØ
F34-04 L/R	5/16"	1"	1-29/32"	3/4"	29/64"	5/16"	5/16"
F34-05 L/R	3/8"	1-1/8"	2-3/32"	7/8"	31/64"	3/8"	3/8"
F34-08 L/R	1/2"	1-13/32"	2-7/16"	1-11/32"	3/4"	1/2"	1/2"
F34-10 L/R	5/8"	1-5/8"	3-3/32"	1-33/64"	7/8"	5/8"	5/8"
F34-12 L/R	3/4"	1-13/16"	3-49/64"	1-51/64"	1"	3/4"	3/4"
F34-16 L/R	1"	2-47/64"	4-41/64"	2-3/32"	1-3/8"	1"	1"

L/R = left-hand / right-hand threads

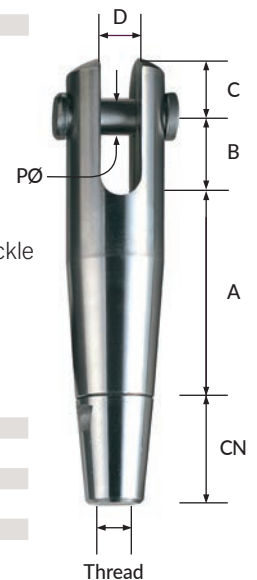
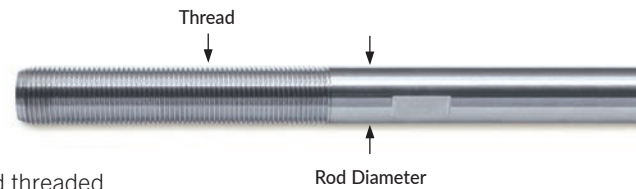

Complete Rod Assemblies

Tension Fork Rod Assemblies

In addition to individual rods and components, Feeney offers complete rod assemblies made to your exact lengths, ready to install. Assemblies come with a left-hand Tension Fork on one end and a right-hand Tension Fork on the other, affording easy adjustment and tensioning without the need for bulky in-line turnbuckles. Simply spin the rod to adjust length. Wrench flats are machined onto each rod so that wrenches can grip without scratching the finish. Assemblies are manufactured to your exact lengths with the Tension Forks set in the mid-adjustment position, allowing maximum adjustment without any exposed threads. See chart below for the plus/minus adjustment for each rod size.

- Each assembly includes a rod, LH and RH Tension Forks, Conical Nuts, Double Headed Clevis Pins, and Rod Connectors (if needed)
- Manufactured from 316-grade stainless steel with a satin finish
- Available in 5/16-in to 1-in diameters
- Rod Connectors are used for all assemblies over 12-ft long
- Assemblies are shipped pre-assembled, with Tef-Gel anti-seize on the threads

Measuring Assembly Lengths

Assemblies are measured from center pin to center pin with the Tension Forks set in the mid-adjustment position. The chart indicates the available plus/minus adjustment range for each rod size. Assemblies are designed so that no threads will ever be exposed if adjustment is kept within the noted ranges.

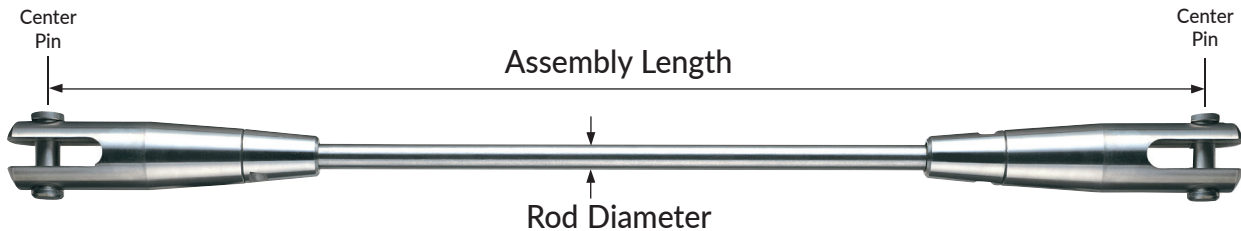

Tension Rod Assembly Standard Adjustment Ranges

Rod Diameter	Adjustment Each End	Adjustment Total Assembly
5/16"	+/- 5/16"	+/- 5/8"
3/8"	+/- 3/8"	+/- 3/4"
1/2"	+/- 1/2"	+/- 1"
5/8"	+/- 5/8"	+/- 1-1/4"
3/4"	+/- 3/4"	+/- 1-1/2"
1"	+/- 1"	+/- 2"

Isolation Washers and Sleeves

- Used to eliminate direct contact of dissimilar metals, thereby minimizing the possibility of electrolysis when attaching Tension Forks to structural members
- Isolation Washers are made from nylon and Isolation Sleeves are made from glass-filled nylon for extra high compression strength and durability
- All Washers and Sleeves are special order items





Installing Your Rod Assemblies

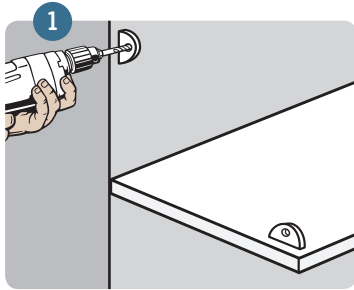

1 Mark and drill holes in the framework (or install eyebolts). Be sure the material thickness, hole diameter, and hole position allow for the fork opening and clevis pin to fit properly.

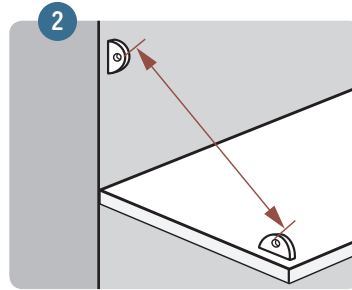

2 Measure between the bearing edges of the attachment holes and calculate the assembly lengths for ordering.

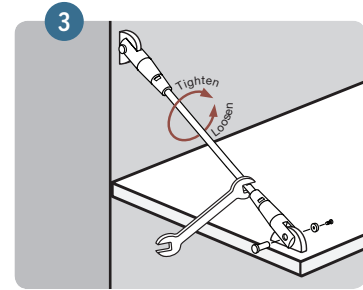

3 Loosely attach the rod assembly by fastening the fork ends to each hole using the removable clevis pins. If necessary, spin both forks equally to adjust length. Adjust final tension by turning the rod with a wrench.



HOW TO ORDER FEENEY ROD COMPONENTS AND ASSEMBLIES

- 1) **Carefully Review:** Read all information provided in this catalog and on our website www.feeneeyinc.com. For questions and assistance, please call our sales department toll-free, 1-800-888-2418.
- 2) **Select Fittings and Sizes:** Select the diameter of rod and type of fittings needed for your project application.
- 3) **Measure Lengths:** Calculate the center pin to center pin lengths for each of your assemblies.
- 4) **Determine Quantities:** Count the number of assemblies you will need.
- 5) **Check Accessories:** Note any isolation sleeves, washers, or connectors you may require.
- 6) **Confirm Details and Prices:** All projects are unique. Call us at 1-800-888-2418, and our staff will assist you in confirming a list of the parts needed for your project and provide you with a price quote.
- 7) **Place Your Order:** Please call, fax, or e-mail us your final list for order processing. Standard orders ship via common truck carrier, freight collect.

2 YEAR LIMITED WARRANTY

Feeney, Inc. warrants that all Feeney stainless steel rods and connectors shall be free from defects in material and workmanship under normal use, conditions, installation, and maintenance in accordance with product specifications for two (2) years from date of purchase. The complete warranty is available on our website www.feeneeyinc.com

FREE: 1-800-888-2418
PH: 1-510-893-9473
FAX: 1-510-788-6041

SALES@FEENEYINC.COM
WWW.FEENEYINC.COM

IMPORTANT NOTE

Building codes vary by state, county, and city, so be sure to consult with your local building department before starting your project.

Trellises

Stylish, Easy-to-Install Trellises for Residential and Commercial Settings.

Drawing from our vast experience with aluminum frames and stainless steel cables, rods, and fittings, we have developed a selection of attractive vertical trellises for residential and commercial settings.

The trellises are sold in complete, easy-to-use kits with powder-coated aluminum support frames and sleek stainless steel cable and rod vine grids. These trellises are perfect for displaying light- to medium-weight foliage and offer simple, elegant design details with exceptional versatility and easy installation. Use them to minimize UV exposure on walls, control ambient heat gain, frame a lovely view, direct foot traffic, or create a cool, relaxing retreat or entertaining area.

- Complete, easy to install kits available in an assortment of sizes and mounting options
- Aluminum support frames and brackets with durable, powder-coated finishes
- 316-grade stainless steel cables & rods for lasting beauty and weather-tough strength
- Fully adjustable rods with special Micro Cross-Clamp connectors
- Variety of uses: extending gardens vertically, vegetable supports, privacy panels, space dividers, sun shades, decorative backdrops, and more
- Multiple kits can be combined to create the landscape design you desire
- Detail drawings and 3-part specifications available at www.feeneyinc.com/garden
- Toll-free information and assistance line, 1-800-888-2418
- Product contains recycled material 





3-in-1 Wall Mount Trellis



The 3-in-1 trellis is a complete, easy-to assemble, all stainless steel wall mount trellis kit with 1/8-in diameter rods and special mounting components that can be configured into any one of 3 trellis design layouts (Fan, Grid, or Diamond), or you can create your own designs.



Rods come in 48-in lengths that can be spliced together using Connector Tubes (included), and they are supported by specially designed 2-in Stand-Off fittings that screw into the wall. Micro Cross-Clamp fittings securely hold intersecting rods in position using locking setscrews. All rods and components are made from high quality 316-grade stainless steel for weather-tough durability, low maintenance, and lasting beauty. Kits include all mounting hardware and installation instructions for building any one of the 3 standard layouts, plus a time saving layout template.

Each 3-in-1 trellis kit includes the following:

- 12 stainless steel 2-in Stand-Off fittings with mounting hanger bolts
- 13 stainless steel rods (48-in long)
- 6 stainless Rod Connector Tubes
- 16 stainless steel Micro Cross-Clamp fittings
- 12 plastic anchor inserts (for masonry/concrete)
- Installation instructions
- Layout template
- Hanger bolt installation tool
- Hex key wrench

Part#	Description	Possible Layouts
8900	3-in-1 Trellis Kit	Fan, Grid, or Diamond

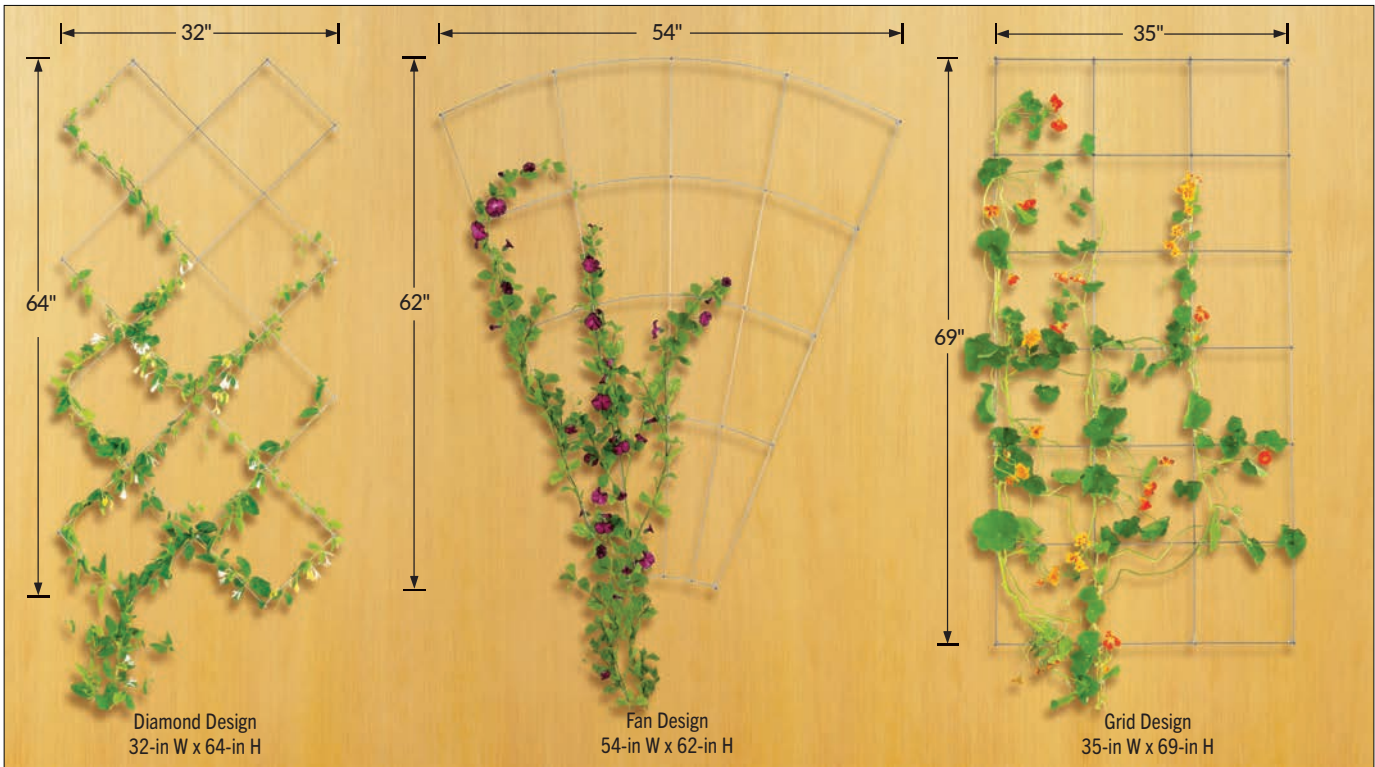

Trellises are spaced 2-in from wall.

Exclusive Design Details



2-in Stand-Off fittings support the lattice structure. They attach to the wall using a threaded hanger bolt.



Micro Cross-Clamp fittings use a locking setscrew to securely fasten crisscrossing rods.



Slender Connector Tubes splice rods together to extend rod lengths beyond 48-in.

Installing The 3-in-1 Trellis

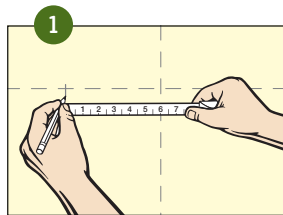

Mark layout on wall using tape measure or template (included).

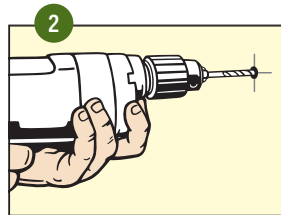

Drill holes to mount the Stand-Off fittings.

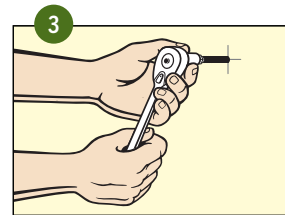

Screw the Stand-Off fittings to the wall.

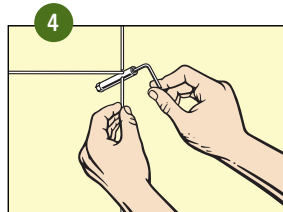

Lace the rods through the Stand-Off fittings and secure by tightening the setscrews.

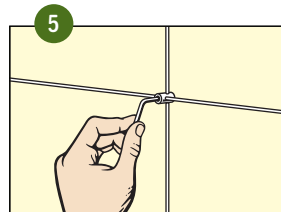

Connect intersecting rods with Micro Cross-Clamp fittings.

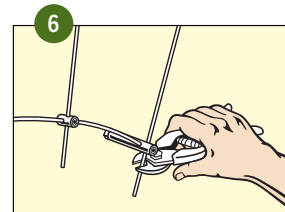

Trim the excess rod, and you're done.

Somerset® II Wall Mount Trellis



The Somerset®II trellis is designed for easy mounting onto walls or fences. It consists of two 40-in long powder-coated aluminum brackets, top and bottom, that screw to the wall face and support a lattice of four vertical 1/8-in diameter stainless steel cables and five horizontal 1/8-in diameter rods. The support brackets can be spaced from 2 to 6-ft apart to fit a variety of wall heights.



Also available in Arch Top style, #8707-BLK

Special setscrew-locking Threaded Terminal cable fittings allow the cable assemblies to be easily trimmed and assembled to exact length in the field during installation. Special Micro Cross-Clamps with locking setscrews securely hold the rods in position. All rods, cables, and components are made from high quality 316-grade stainless steel for weather-tough durability, low maintenance, and lasting beauty. Multiple kits can be mounted adjacent to one another to make wider trellises, and each kit includes all mounting screws, hardware, and installation instructions.

Each Somerset®II trellis kit includes the following:

- 2 powder-coated aluminum support brackets with mounting hardware
- 4 stainless cables with attachment fittings
- 5 stainless rods with Micro Cross-Clamps
- 4 plastic anchor inserts (for concrete/masonry)
- Installation instructions
- Hex key wrenches

Part#	Description	*Bracket Color
8706F-BLK	Somerset® II Trellis Kit	Black Matte
8707-BLK	Somerset® II Arch-Top Trellis Kit	Black Matte

*Powder coated finishes meet rigorous AAMA-2604 coating specifications for superior color retention, impact resistance, and weather protection. Additional colors are available on a custom quote, custom order basis.

Adjustable to fit your wall height

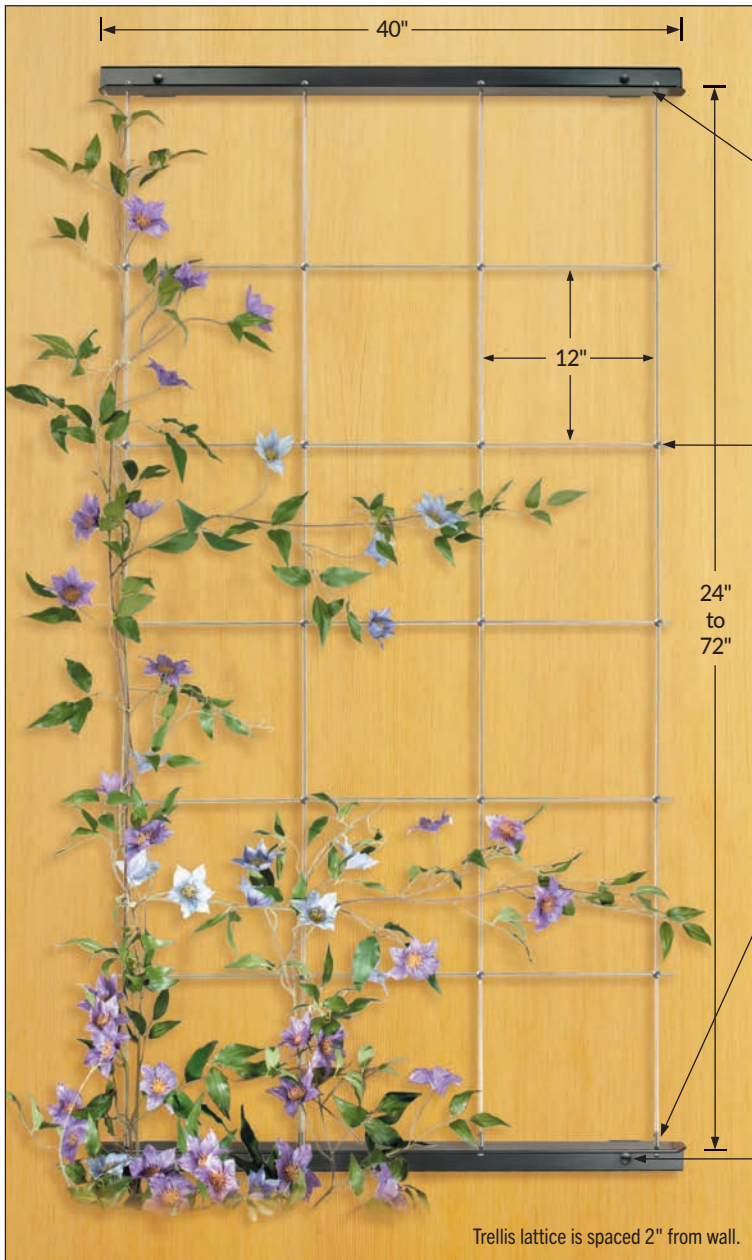

Exclusive Design Details

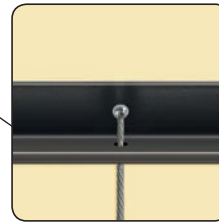

Each cable comes with a small stainless steel Ball fitting pre-attached to one end.

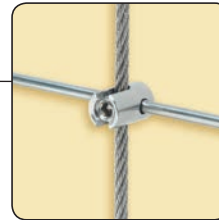

Micro Cross-Clamps use a locking setscrew to firmly hold the rods in position.

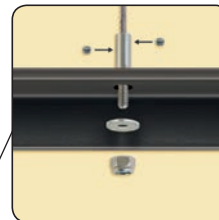

Special Threaded Terminal fittings are attached to the cable in the field using two offsetting setscrews. Anti-loosening nylon-insert locknuts securely fasten the cables to the bottom bracket and are used to adjust tension.

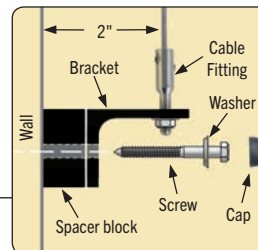

1/2-in thick spacer blocks hold the brackets away from the wall for proper lattice clearance and optimal water drainage. Mounting screws are inserted through the bracket and spacer blocks and into the wall and are finished with decorative caps.

Installing The Somerset® II Trellis

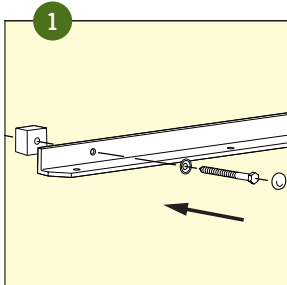

1 Securely screw top and bottom support brackets to wall. Check that brackets are level and vertically aligned with one another. Brackets may be spaced 2-ft to 6-ft apart.

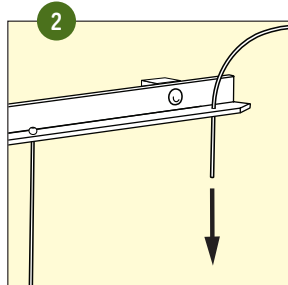

2 Lace cables through holes in top brackets and let them hang freely on the Ball fittings.

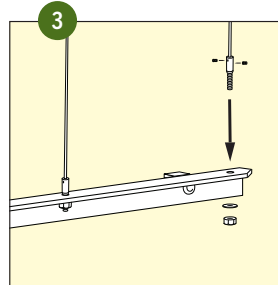

3 Trim cables to proper length and attach Threaded Terminals using setscrews. Fasten and tighten Terminals to bottom bracket with nylon-insert locknut.

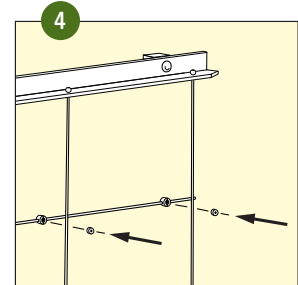

4 Position and fasten horizontal rods to cables using Micro Cross-Clamps.

Greenway Freestanding Trellis



The Greenway is a freestanding trellis panel kit (43-in w x 72-in h) made from 1½-in diameter aluminum tubing sections with a durable powder coated finish. The pre-cut tubing sections are easily assembled using connecting splice sleeves and screws.



Four ½-in diameter stainless steel cables with adjustable threaded end fittings are strung vertically on the frame, and they support four ½-in diameter stainless steel rods that are attached horizontally using special Micro Cross-Clamps with locking setscrews. The rods may be positioned anywhere along the cables, but the recommended spacing is 11¼-in apart. The frame legs can either be set in compacted gravel or concrete footings, or they can be trimmed and fitted with surface mount Base Plates (sold separately). All rods, cables, and components are made from high quality 316-grade stainless steel for weather-tough durability, low maintenance, and lasting beauty. Multiple trellis kits can be combined in a variety of ways to create the landscape effect you desire. Kits include all necessary hardware and installation instructions.



Each Greenway trellis kit includes the following:

- 1 powder coated aluminum tubular frame (comprised of 4 sections with complete assembly hardware)
- 4 stainless cable assemblies with attachment fittings
- 4 stainless rods with Micro Cross-Clamps
- Installation instructions
- Hex key wrench
- Square-drive bit

Part#	Description	*Frame Color
8705-BLK	Greenway Trellis Kit	Black Matte

Each Base Plate kit includes the following:

- 2 powder coated aluminum Base Plates (5-in diameter) with connecting splice sleeves and locking screws
- 6 stainless mounting screws (¼"x 2") with washers and cover caps
- 6 plastic anchor inserts (for concrete or masonry installations)
- Installation instructions

Part#	Description	*Frame Color
8451-BLK	Greenway Base Plate Kit	Black Matte

*Powder coated finishes meet rigorous AAMA-2604 coating specifications for superior color retention, impact resistance, and weather protection. Additional colors are available on a custom quote, custom order basis.

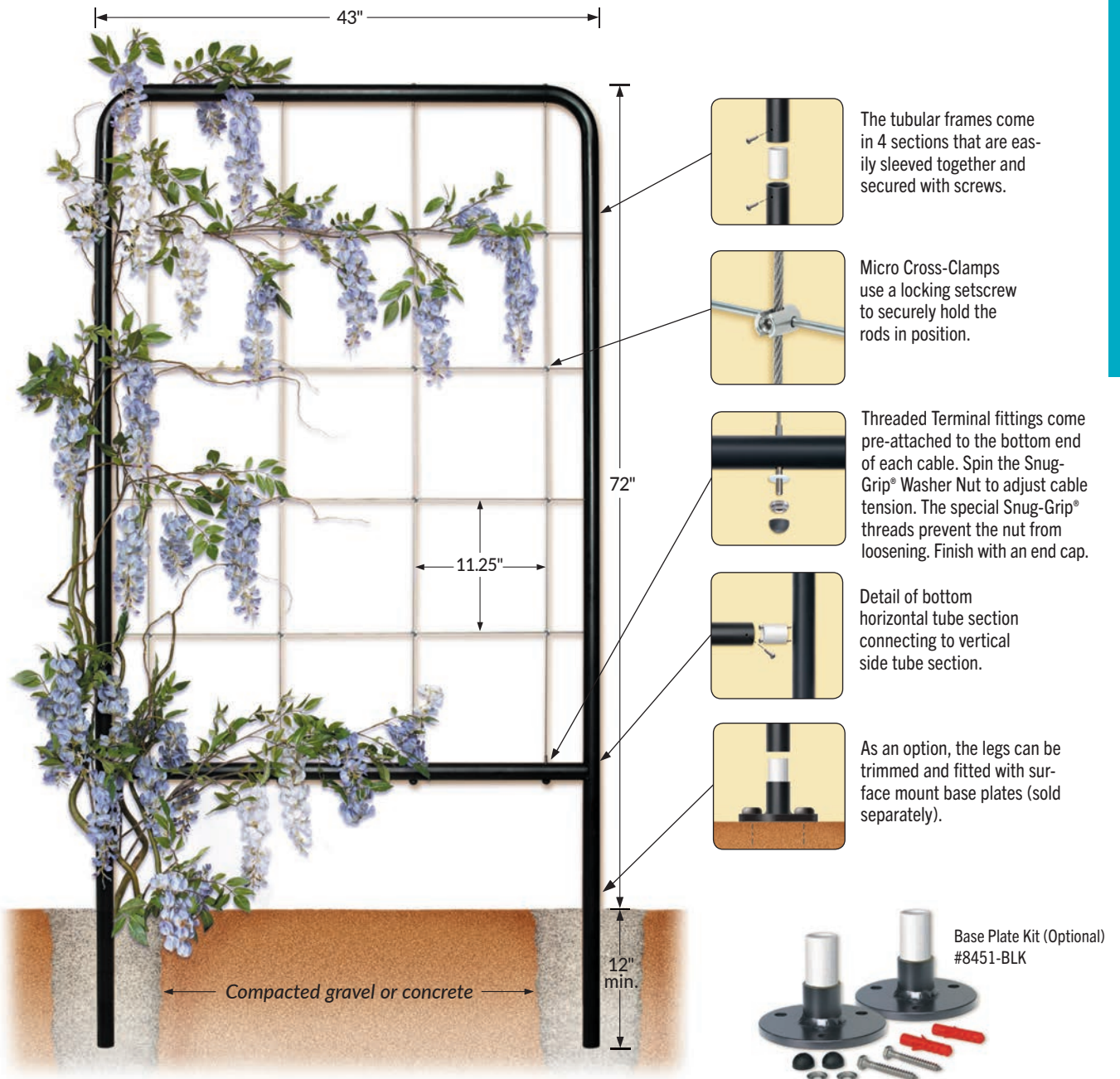

The tubular frames come in 4 sections that are easily sleeved together and secured with screws.

Micro Cross-Clamps use a locking setscrew to securely hold the rods in position.

Threaded Terminal fittings come pre-attached to the bottom end of each cable. Spin the Snug-Grip® Washer Nut to adjust cable tension. The special Snug-Grip® threads prevent the nut from loosening. Finish with an end cap.

Detail of bottom horizontal tube section connecting to vertical side tube section.

As an option, the legs can be trimmed and fitted with surface mount base plates (sold separately).

Base Plate Kit (Optional)
#8451-BLK



Installing The Greenway Trellis

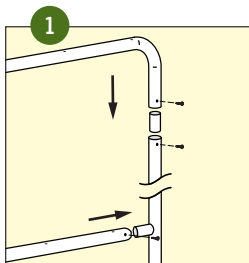

1 On a flat surface assemble the tubular frame using connecting splice sleeves and screws.

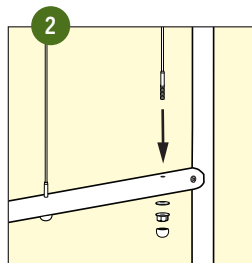

2 Attach and tighten the vertical cables. Threaded Terminal fittings on the bottom and Fixed Button Head fittings on top.

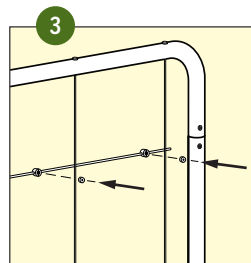

3 Position and fasten the horizontal rods to the cables using the Micro Cross-Clamps with locking setscrews.

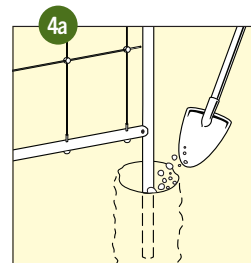

4a Dig holes and lift the trellis frame into position. Carefully fill the holes with gravel or concrete; check alignment frequently.

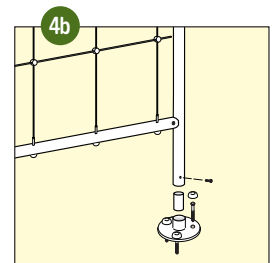

or 4b Trim legs to desired length and attach Base Plates (sold separately). Lift frame into position and securely screw plates to floor or deck surface.

HOW TO ORDER TRELLIS KITS

- Carefully Review:** Read all product information provided in this catalog and on our website www.feeneyinc.com/garden. If you have questions, please call our sales department for assistance, 1-800-888-2418.
- Select Trellis Style:** Wall mounted Somerset® II, or 3-in-1, or freestanding Greenway.
- Determine Quantities:** Select the quantity of trellises needed.
- Check Accessories:** Make sure that you have all of the necessary accessories and tools.
- Place Your Order:** Please call, fax, or e-mail us your final list for order processing. Orders ship via UPS.

FREE: 1-800-888-2418

PH: 1-510-893-9473

FAX: 1-510-788-6041

SALES@FEENEYINC.COM

WWW.FEENEYINC.COM/GARDEN

5 YEAR LIMITED WARRANTY

Feeney, Inc. warrants that all trellis kits (aluminum support frames and stainless steel cables, rods, and connectors) shall be free from defects in material and workmanship under normal use, conditions, installation, and maintenance in accordance with product specifications for five (5) years from date of purchase. The complete warranty is available on our website www.feeneyinc.com/garden

Tools & Accessories



CABLE CUTTERS

- For trimming excess cable or rod on the Somerset®II and 3-in-1 trellises
- ▲ **WARNING:** This product can expose you to Di(2-ethylhexyl)phthalate (DEHP) which has been determined by the State of California to cause cancer and birth defects or other reproductive harm. For more information go to www.P65Warnings.ca.gov

Part#	Description
2972-PKG	7-1/2" long, for cable/rod up to 1/8"Ø



HANGER BOLT INSTALLATION TOOL

- For easily installing Stand-Off fitting hanger bolts
- Hexagonal shaft fits 1/2-in electric drill or 3/8-in socket wrench

Part#	Description
3988	1/4-20RH threads x 7/8" long



STAND-OFF FITTINGS (316-Stainless)

- For attaching rods to walls to create custom trellis layouts
- Double-hole design can support either a single rod or two crossing rods
- Each fitting includes a 2-in Stand-Off body with locking setscrew, hanger bolt, hex nut, and plastic anchor insert (for masonry/concrete)

Part#	Description
8406	3/8"Ø x 2" long tubular body, for 1/8"Ø rods



ROD CONNECTOR TUBES (316-Stainless)

- For splicing rods together to extend rod lengths

Part#	Description
22208F	3/16"Ø x 1-5/8" long, for 1/8"Ø rods



RODS (316-Stainless)

- For creating custom trellis designs or adding more rods to the Somerset®II or Greenway
- Use with Stand-Off, Cross-Clamp, and Connector Tube fittings

Part#	Description
8420	1/8"Ø x 38" long
1445	1/8"Ø x 48" long



MICRO CROSS-CLAMPS (316-Stainless)

- For attaching two intersecting 1/8-in Ø rods/cables
- Each fitting includes a locking setscrew

Part#	Description
8402	3/8"Ø x 9/16" long, 2-hole (rods/cables must be laced through each hole)
8404	3/8"Ø x 9/16" long, slotted (quick attachment to pre-hung cables/rods)

IMPORTANT NOTE: Never attach trellises to vinyl siding, stucco, Dryvit® or other synthetic or natural construction material walls where the structural integrity is uncertain or where possible penetration of a moisture barrier membrane may create a potential for water leakage or damage or may violate and void any product warranties. Be sure to carefully seal any wall penetrations with the proper sealant materials. Consult a construction expert for advice on your specific conditions.

Building codes vary by state, county, and city, so be sure to consult with your local building department before starting your project.





Also see us on:



For assistance with questions or locating a dealer in your area, please give us a call at 1-800-888-2418 or visit our website www.feeneyinc.com for complete product information.

SALES LOCATIONS

(All locations)

Toll free: 1-800-888-2418

Email: sales@feeneyinc.com

2603 Union Street
Oakland, CA 94607
Fx: 1-510-788-6041

2190 West 11th Ave., #222
Eugene, OR 97402
Fx: 1-866-215-4119

12655 SW Center Street, #325
Beaverton, OR 97005
Fx: 1-510-788-6041

4400 Veterans Memorial Hwy., #206
Holbrook, NY 11741
Fx: 1-631-285-7198

108 Water Street, #3B
Watertown, MA 02472
Fx: 1-510-788-6041

MEMBER OF



MAKES IT EASY