

Installation Instructions for Fortress Fe²⁶ Railing Traditional Railing Panels with Universal (UB) Brackets and Iron Posts

It is the responsibility of the installer to meet all code and safety requirements, and to obtain all required building permits. The deck and railing installer should determine and implement appropriate installation techniques for each installation situation. The Fortress Company or its distributors shall not be held liable for improper or unsafe installations.

Fortress Iron Posts must always be secured to the deck framing. Fortress Iron Posts should never be attached to only the deck boards.

Note

When cutting Fortress railing, it is very important to complete the following at cut points. Not following the below steps will result in rust at the cut areas:

- Remove all metal shavings from the cut area
- File any sharp edges left by cutting. Thoroughly wipe and remove any filings, grime or dirt from the railing.
- Apply two coats of Fortress zinc based touch-up paint to the cut area. If touch up is at rail ends, allow paint to dry before connecting bracket to post.
- Be sure to remove any metal shavings from the surface of deck, patio or balcony to prevent rust on the surface.

Required Materials

Drill, Drill Bits, T-25 Driver Bit, Drill Bit Extender, Tape Measure, Wrenches, Speed Square, Center Punch, and Hammer.

Mount Iron Posts*

- Wood Blocking tied to deck frame must be installed and constructed with treated dimensional lumber with a minimum thickness of 1/1/2".
- Position the edge of post base plate a minimum of 1/2" from the inside edge of rim joist.
- Mount posts at appropriate points based on panel length.
- Attach Iron posts with 3/8 X 3-1/2" Hex Head Galvanized Bolts.

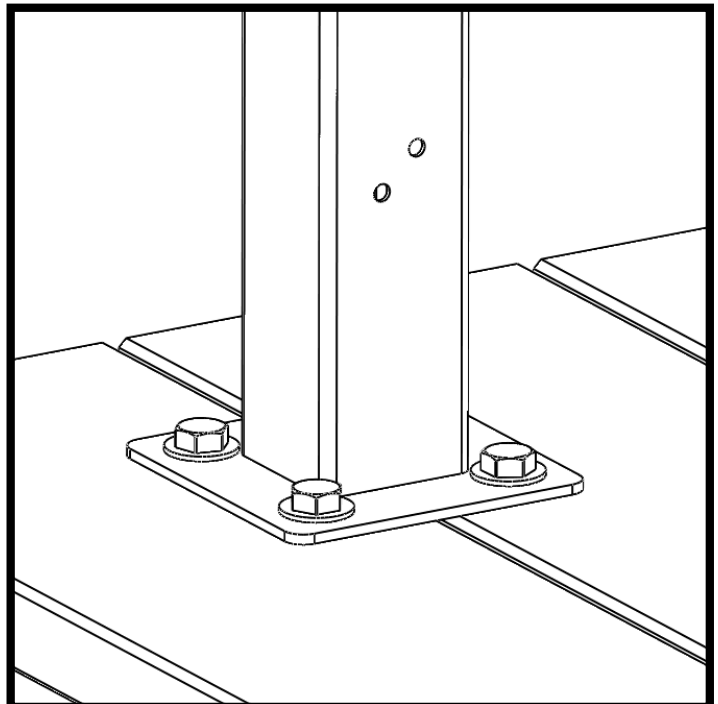
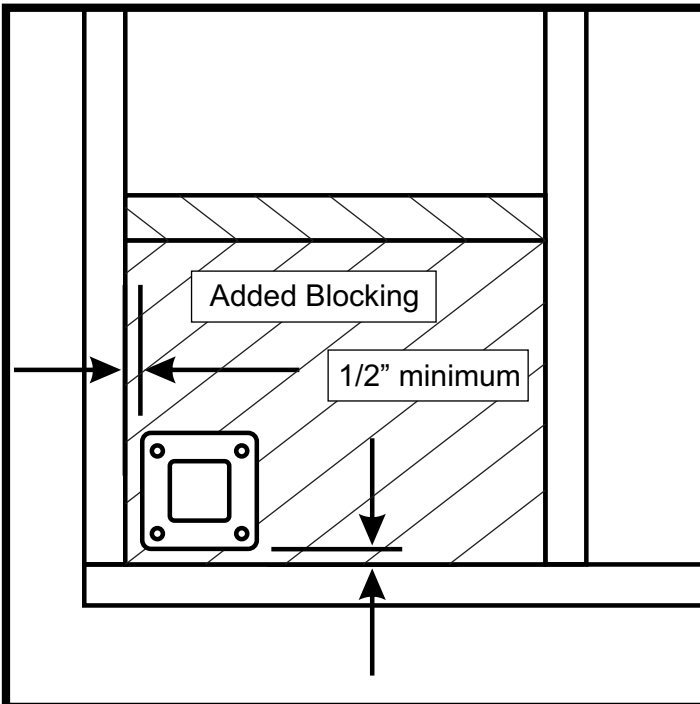

*Reference Fortress iron post mounting instructions

Fe²⁶ Traditional Panel Installation Options

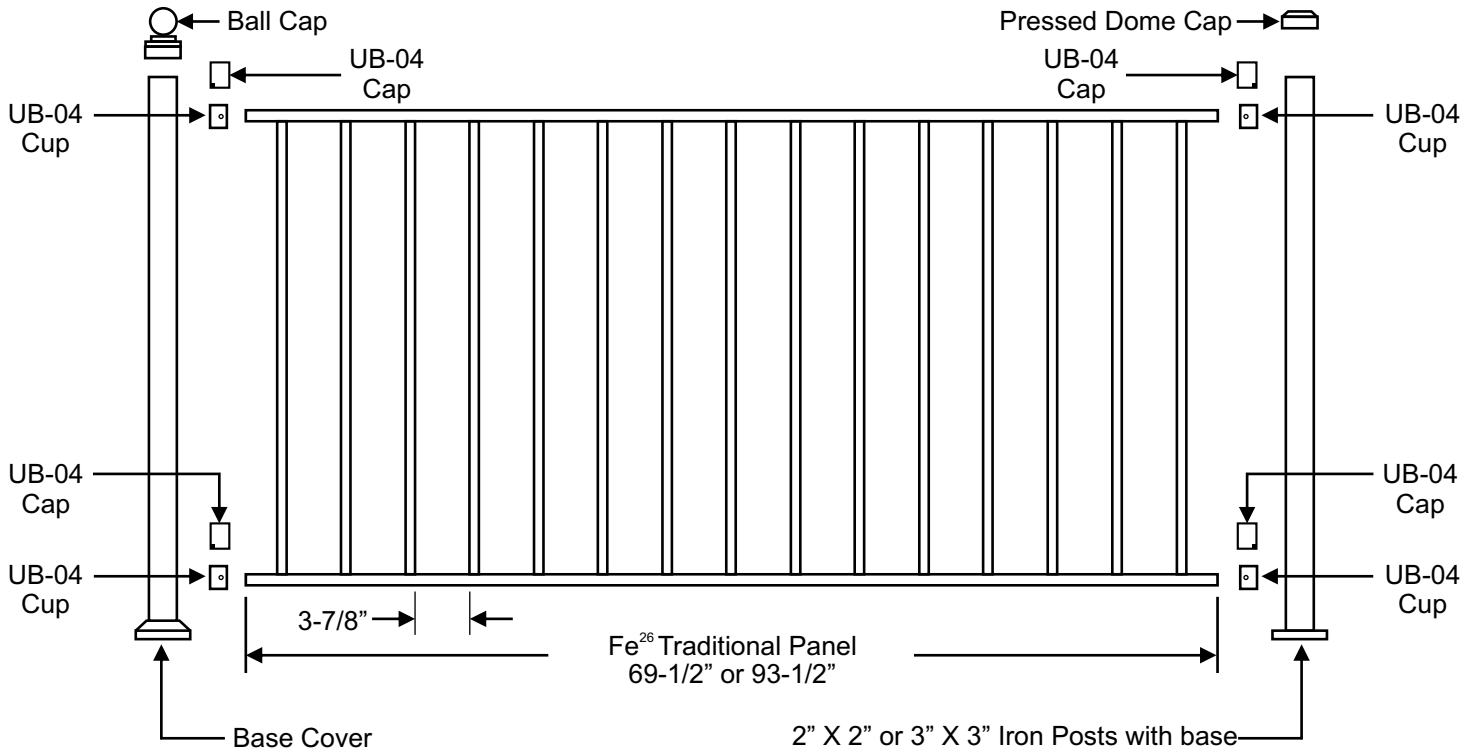

Fe²⁶ Traditional Panel with Accent Top Panel Installation Options

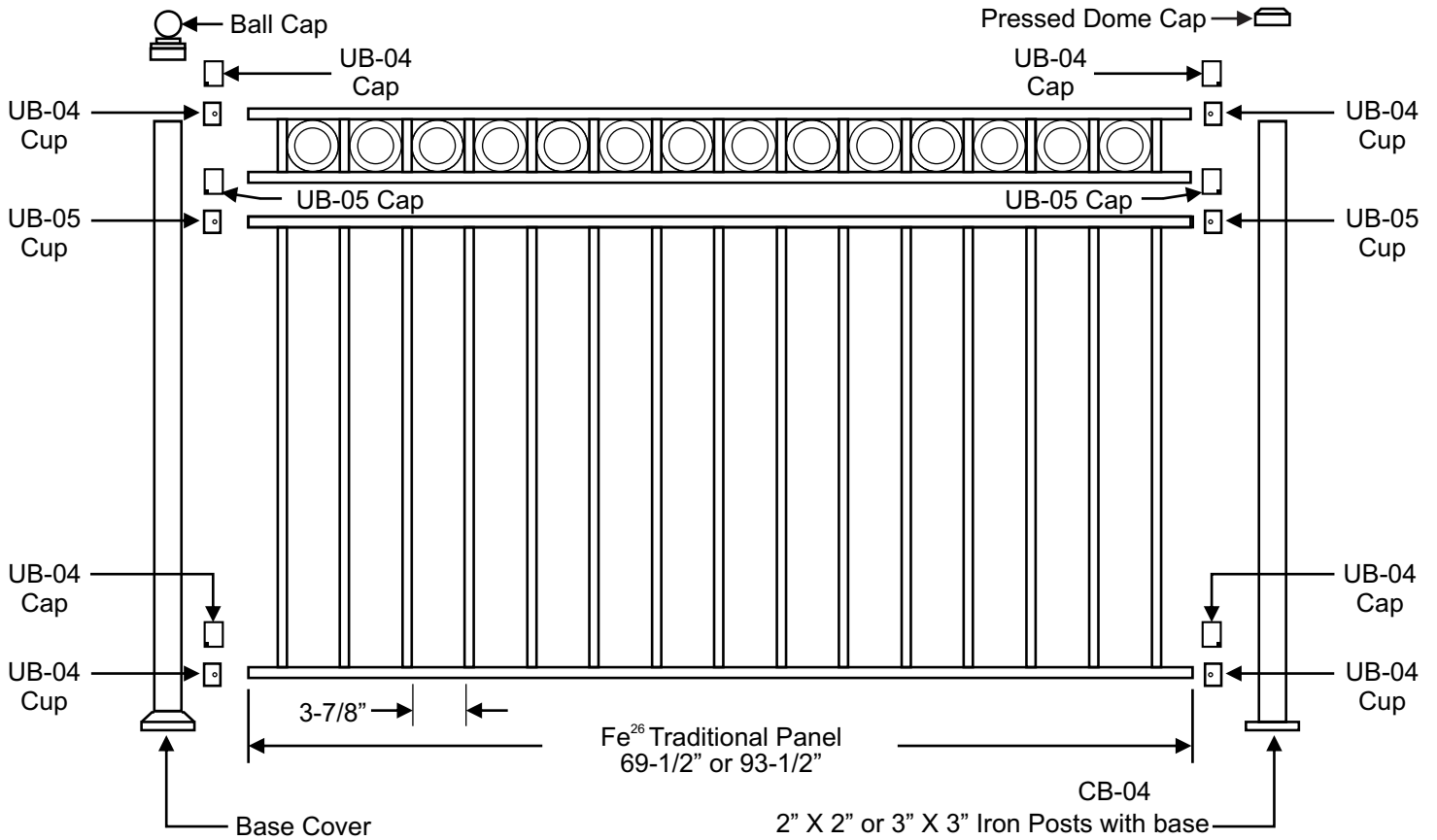

Fe²⁶ Traditional Panel and Iron Post Configurations

Rail Panel Height	Rail Panel Only		Railing Panel with Accent Top Panel	
	Installed Panel Height*	Required Post	Installed Panel Height with ATP*	Required Post
28"	X	X	36-1/2"	39-1/2"
34"	37-3/4"	39-1/2"	42-1/2"	45-1/2"
40"	43-3/4"	45-1/2"	X	X

*Heights includes a 3-3/4" space between deck surface and bottom edge of bottom rail.

UB-04 Bracket Hole Locations for Fe²⁶ Traditional Panel Installations

Pre-Drilling with a 5/32" drill bit is required.

Rail Panel Height	Pre-Drill Dimensions			
	A*	B	C	D
28"	X	X	X	X
34"	4"	1/2"	37"	1/2"
40"	4"	1/2"	43"	1/2"

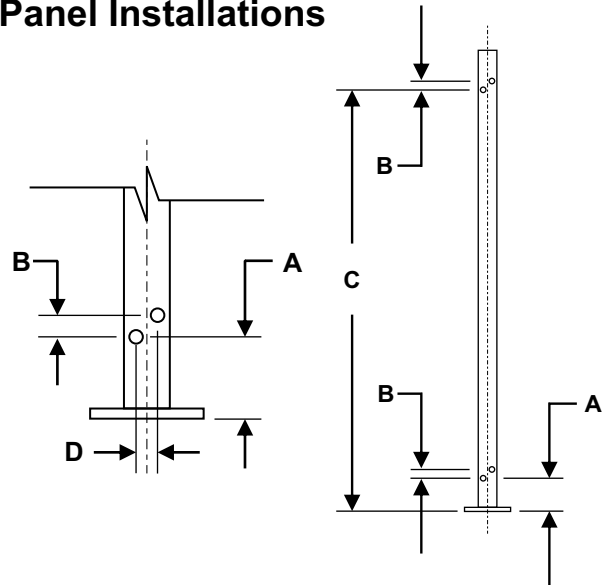

*Dimension A positions bottom edge of rail 3-3/4" above deck surface.
*Dimension A is measured from the bottom surface of post base.

Remove all metal shavings from deck, post base cover, post, and panel before bracket is screwed to post to prevent rust stains.

Fe²⁶ Traditional Panel Installation with UB-04

When using UB-04 brackets rails MUST be cut 1/2" shorter than the distance between posts. 1/4" should be cut from the end of each rail to keep rail panel centered between posts.

- If rails were cut to length, file cut edges and coat with 2 coats of Fortress zinc based touch-up paint.
- Check fit of rail between installed posts.
- If using a Base Cover install it now by sliding over the top of Iron Post.
- Secure UB-04 brackets to posts with provided metal screws. Use two screws per bracket. Use low speed setting on drill.
- Drop Fe²⁶ Panel into installed UB-04 brackets.
- Secure rails with provided set screws at each UB-04 bracket.
- Install UB-04 Caps by sliding the cap over the UB-04 Cup. Cap will snap into place.

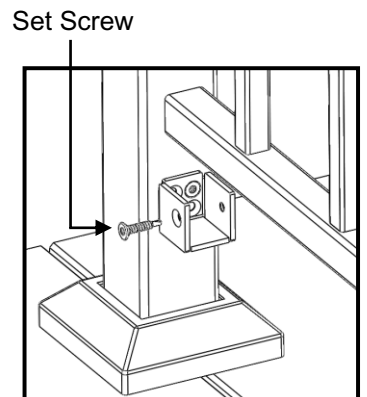
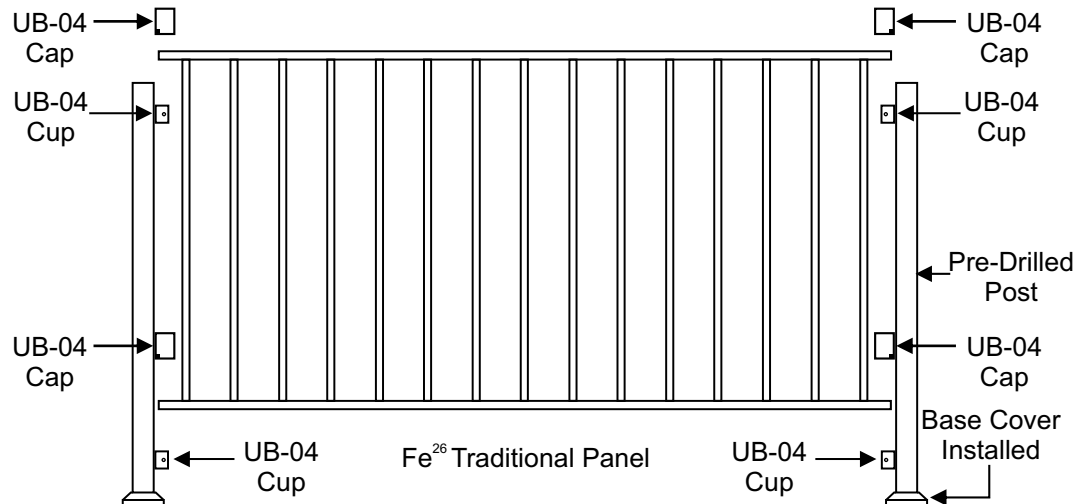

UB Bracket Hole Locations for Fe²⁶ Traditional Panel Installations with Accent Top Panel

Pre-Drilling with a 5/32" drill bit is required.

Rail Panel Height
ATP Panel Height

		Pre-Drill Dimensions						
Rail Panel Height	ATP Panel Height	A*	B	C	D	E	F	G
28"	5"	4"	1/2"	5/8"	31"	5"	1/2"	5/8"
34"	5"	4"	1/2"	5/8"	37"	5"	1/2"	5/8"
40"	5"	X	X	X	X	X	X	X

*Dimension A positions bottom edge of rail 3-3/4" above deck surface.
*Dimension A is measured from the bottom surface of post base.

Remove all metal shavings from deck, post base cover, post, and panel before bracket is screwed to post to prevent rust stains.

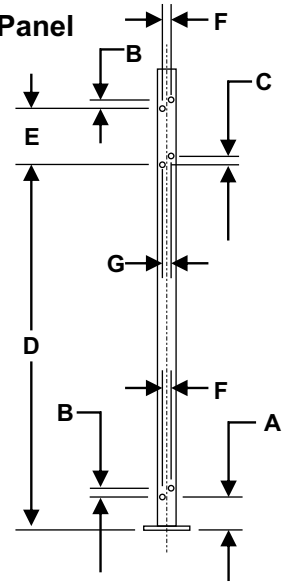

Fe²⁶ Traditional Panel with Accent Top Panel (ATP) Installation with UB-04 and UB-05

When using UB brackets rails **MUST** be cut 1/2" shorter than the distance between posts. 1/4" should be cut from the end of each rail to keep rail panel centered between posts.

- If rails were cut to length, file cut edges and coat with 2 coats of Fortress zinc based touch-up paint.
- Check fit of rail between installed posts.
- If using a Base Cover install it now by sliding over the top of Iron Post.
- Slide ATP panel over the top rail of the Fe²⁶ Traditional Panel
- Secure UB brackets to posts with provided metal screws. Use two screws per bracket. Use low speed setting on drill.
- Drop Fe²⁶ Traditional Panel into installed UB brackets.
- Secure rails with provided set screws at each UB bracket.
- Install UB-04 Caps by sliding the cap over the UB Cup. Cap will snap into place.

