

Installing Post Mounted Accent Light

1 Accent Light wire channel must be routed during the installation of the Post Sleeve. The Post Sleeve and the wood post must be prepared in advance to accommodate installation of the Accent Light. (No post preparation is necessary for the 5" and 5 1/2" Post Sleeves.)

2 If using the 4" Post Sleeve, prepare the wood post by routing a 1/4" wide by 1/4" deep wire channel up the center of the post on the face where the Accent Light will be mounted. For main cable, slightly bevel the corner of the 4x4 post.

3 If a Post Skirt is used, install it over the wood post before installing the Post Sleeve. You will not be able to install Post Skirt after Post Sleeve and Accent Light are in place.

4 Remove Accent Light Cover from Accent Light Back Plate by loosening Set Screw located at bottom of Accent Light Cover.

5 Prepare the Post Sleeve in the following manner:

- Cut the Post Sleeve to the desired length.
- Determine the height the Accent Light will be mounted.
- Mark the location of the wire hole and the mounting screw holes using the template provided on the instructions that come with the product.
- Drill a 3/8" hole for the wire and drill two 7/64" holes for the mounting screws.

6 Route the Accent Light wire through the Back Plate then through the wire hole in the Post Sleeve then invert the Post Sleeve and allow the wire to extend out the top end of the Post Sleeve.

7 Hold the Accent Light Back Plate loosely in position and slide the Post Sleeve over the wood post and into the Post Skirt. Make sure the wire is in the routed wire channel.

8 Attach the Accent Light Back Plate to the post using two #8 x 3/4" screws provided.

9 Re-install Accent Light Cover and secure with Set Screw with Allen Wrench.

10 Trim excess wire and make wiring connections. (See Connections section of manual).

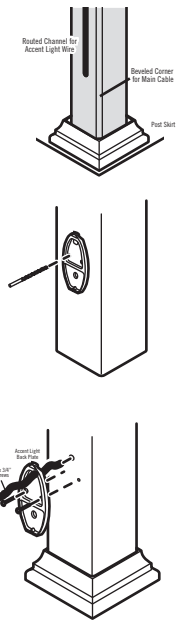

Installing Stair Riser Light

1 Locate and mark vertical and horizontal centerlines for Stair Riser Light location. Level the back plate and secure using #6 x 1" wood screws.

2 Use the back plate as a template to locate the center of the 1" hole for the wire.

3 Cut a 1" diameter hole at the center point, at a slight downward angle, using a 1" spade bit.

4 Trim excess wire length and make wire connection to main circuit wire using wire nuts provided.

5 Align the light with the 1" hole and assure alignment between the Stair Riser light and the back plate.

6 Secure housing to back plate using the set screw with a 2.5mm Allen wrench.

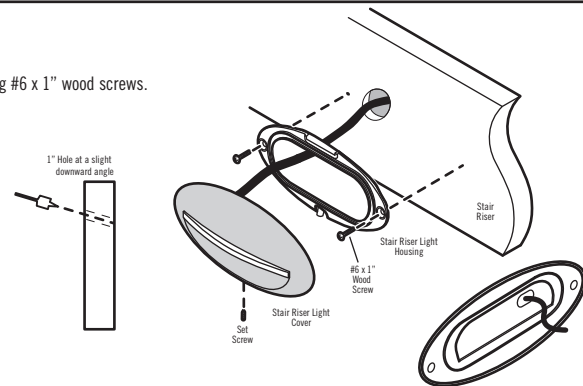

Installing Under-Rail Light

1 Choose the location for the Under-Rail Light so it is centered in the balusters.

2 Drill a 3/8" hole to feed the wire through the RadianceRail Support Rail.

3 Feed the wire and mount the light to the recessed RadianceRail Support Rail making sure the light is tilted in (light comes with a 15° tilt which is usually facing the deck). Use the center alignment beam for a guide for the 2 screws. Use 8-3/4" screw size.

4 Trim excess wire length and make wire connection to main circuit wire using nuts provided.

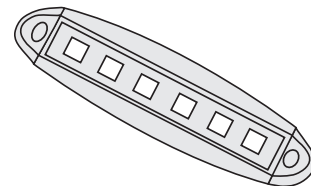

Installing In-Deck Light

! In-deck light should be installed in a low foot-traffic area.

In-deck light can only be used when there is room under the deck to access the wires to make all of the connections

1 Locate and mark the centerline of the deck plank where the in-deck light will be mounted.

2 On the desired point of the center line, use a 1" spade bit to create a through hole (be sure not to drill into the substructure.)

3 Guide the light's wire into the through hole.

4 Push the lighting fixture into the through hole until the flange touches the deck surface.

5 The wire connections can then be made under the deck's surface.

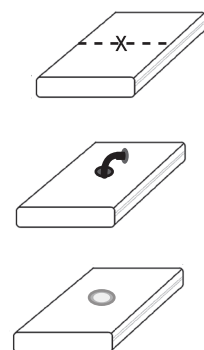

LIGHTING

Components

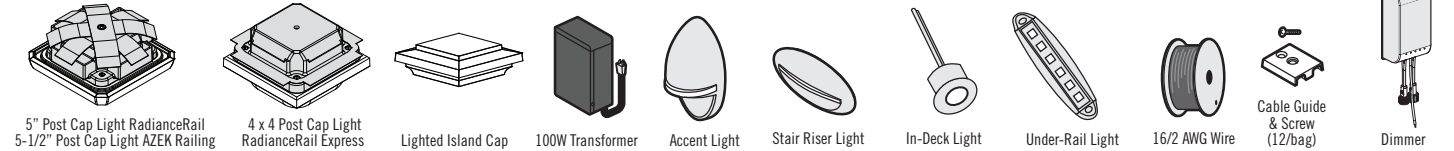

Tools Required

In addition to a basic tool set, you will need the following for installation of the components.

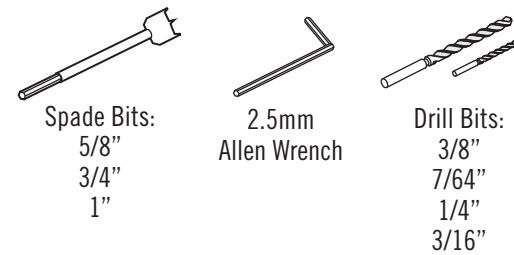

Lighting Layout Overview

The AZEK and TimberTech system is designed for use with AZEK Railing and TimberTech Railing products.

Below is a sample lighting layout showing fixture placement and wiring routes. When laying out the wiring for your deck, keep the following in mind:

• Building codes vary by locale, please consult all applicable codes before beginning project.

• Modifications must be made to railing components during assembly to accommodate wiring and fixtures. Do not begin deck construction until you have read the lighting instructions.

• This unit's secondary wiring shall be protected by routing in close proximity to the luminary or fitting, or next to a building structure such as a house or deck. The wiring shall not be buried except for a maximum 6 inches (15.2cm) in order to connect to the main secondary wire.

• A maximum of 40W can be applied to a single circuit, and no more than 90W should be applied to the transformer. Please refer to the chart below to determine the wattage of each fixture.

• The 16AWG secondary supply wire can be buried to a maximum of 6" for routing under deck or other obstacles. The luminary (unit secondary) wires cannot be buried underground.

• Luminaries shall not be installed within 10 feet (1.52m) of pool, spa or fountain.

• Trim post covers to correct length - see Post and Rail Prep page.

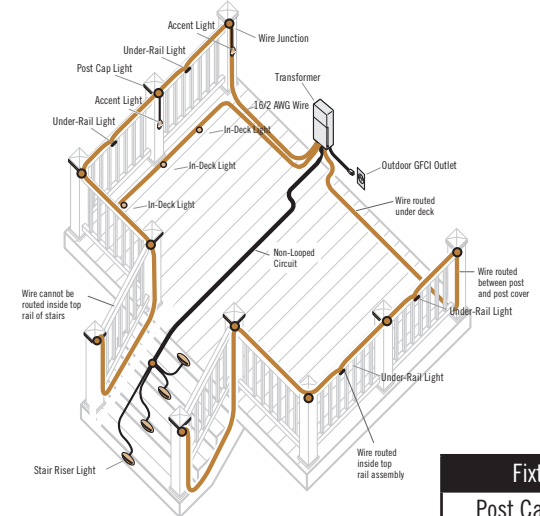

Fixture	Wattage
Post Cap Light	4W
Lighted Island Cap	2W
Accent	2W
Under Rail	2W
Stair Riser	2W
In-Deck	1W

Manufactured for use with:



Visit www.timbertech.com/installation to view TimberTech installation videos, and www.azek.com/installation to view AZEK installation videos

SAVE THESE INSTRUCTIONS

Wiring Instructions

Wire Connections

Connections between the main 16/2AWG cable and the lighting fixtures are made using the space between the post and the Post Cap Light as a junction box.

When routing the main wire around the deck, leave a loop of extra wire at the top of each post to allow for splicing connections.

Use silicone filled wire nuts with corrosion protection and intended for outdoor use to make all connections. They shall be copper, copper alloy, or the equivalent.

When making splices, **do not pre-twist wires**. Pre-twisting wires can lead to a poor seal inside the wire nut causing corrosion and/or voltage drop.

Wire Nut Instructions

Use the following guidelines for correct usage of wire nuts.

IMPORTANT: Turn off power before installing or removing connector. Product to be used in accordance with local and national codes.

- Strip wires 5/8"
- Align frayed strands of conductors.
- Do not pre-twist. Place stripped wires together with ends even, but lead smaller stranded wires slightly ahead of larger solid or stranded wire.
- Twist connector onto wires pushing firmly until hand-tight. DO NOT over torque.
- Wipe excess sealant in and around conductors. DO NOT REUSE.

Transformer Connections

Consult the instructions provided with the transformer for additional information.

Power is supplied to the lighting fixtures via 16/2AWG wires connected to the provided transformer. One side of the 16/2AWG wire is connected to the Common terminal (C), the other side is connected to an Output terminal. One side of the 16/2AWG wire contains raised ridges to allow for easy identification (see Wire Connections section). The maximum recommended load for the transformer is 90 watts.

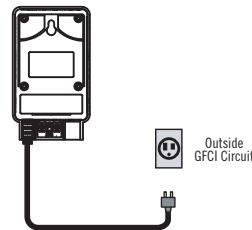

Transformer Settings

100 Watt Transformer	
On	Turns unit on
Off	Turns unit off
Auto	Photocell Control "Auto" – Lights come on at dusk and go off at dawn
4H	Stays on 4 hours after dusk
6H	Stays on 6 hours after dusk
8H	Stays on 8 hours after dusk

Dimmer Instructions

Install the Dimmer next to the LED Transformer. Use the provided 10" wire and water-tight connector to connect the Dimmer to the LED Transformer. Next, use the provided 10' wire and water-tight connector to connect the Dimmer to main run of wire.

To use the Dimmer, turn the LED Transformer to a setting that turns the lighting on when desired. To dim the lights, press the button on the remote or on the dimmer until the desired brightness is achieved.

Recommended load for the dimmer is between 20-90 watts.

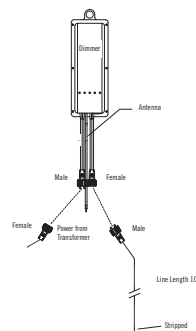

Post & Rail Preparation

5" Post Cap Light RadianceRail 5-1/2" Post Cap Light AZEK Railing Lighted Island Cap

Post & Post Sleeves

(The following instructions are for a rail height of 36")

- Trim 4x4 wood posts 2 1/2" shorter than the finished Post Sleeve length.
- Trim Post Sleeves to length: 39-40" for a lit post, 2 1/2" longer for unlit post.

For best results, use a miter saw with a fine toothed blade to make Post Sleeve cuts. Check cuts for square.

- Feed main 16/2AWG cable between post and Post Sleeve. (See Wire Connections section for more info.)

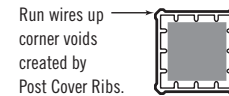

Railing

- Install Support Rails and Balusters as normal, DO NOT install Top Rail yet.

- Drill a 5/8" hole through the Post Sleeve on centerline, directly above rail Mounting Blocks.



- After running all wiring, secure four Cable Guides to Support Rail using #8 x 3/4" screws. Use the Cable Guides to pre-drill holes thru the Support Rail with a 7/64" bit.

Cable Guide Placement

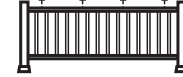

- Make a notch on the centerline of the Top Rail by boring a 3/4" hole centered 1/2" back from the end of the rail, then cut it out to form an open slot.



- Attach Top Rails before installation of Post Cap Lights. Use the holes that were pre-drilled through the Cable Guides to attach the Top Rail. FAILURE TO USE THESE HOLES MAY RESULT IN WIRE DAMAGE.

4 x 4: RadianceRail Express

Post & Post Sleeves

(The following instructions are for a rail height of 36")

- Trim 4x4 wood posts 2 1/2" shorter than the finished post sleeve length.
- In order to provide clearance for wiring between the post and Post Cover you must create a wire channel.

Rout a 1/4" by 1/4" slot down the post

OR
Chamfer the corner of the post

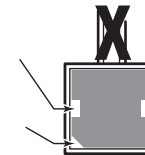

NOTE: Do not rout a wire channel where a rail is to be mounted.

- If you plan to install a post mounted Accent Light, you must rout a slot down the post to the desired fixture position. (See Accent Light instructions.)
- Trim Post Covers to length: 37-5/8" for a lit post, 39" for an unlit post. For best results, use a miter saw with a fine toothed blade to make Post Cover cuts. Check cuts for square.
- Feed main 16/2AWG cable up or down post using prepared feature. (See Wire Connections section for more information)

Installing Post Cap Light

Post Lamps must be installed after the rail assembly has been completed.



Before installing, refer to Post & Rail Preparation section.

- Install the Lens onto the Post Sleeve as shown.
- Remove the Post Lamp Cover from the Post Lamp Bottom Housing.
- Trim excess wire length and make wiring connections to 16/2AWG main cable and other 18/2AWG luminary wires. **Check to confirm polarity of main cable connections.**
- Coil the connected wires inside the Post Sleeve and insert the Post Lamp Bottom Housing into the Lens. Check to make sure no wires are exposed or pinched between Lens and Bottom Housing.
- Install the mounting screws and washers assembled as shown. **Watch as screws are installed to ensure that wires are clear of screw tip prior to driving them into the wood post. Tighten only until the silicone washer begins to compress. Over-tightening could break the Bottom Housing causing permanent damage.**
- Reinstall Post Lamp Cover and screws.
- a For 5" & 5-1/2": (Includes Gasket) Rotate Gasket for desired fit of Post Cap.
b For 4x4 (Includes Gasket): Set gasket centered on post Lamp Cover.
- Install Post Cap onto Post Lamp Cover.

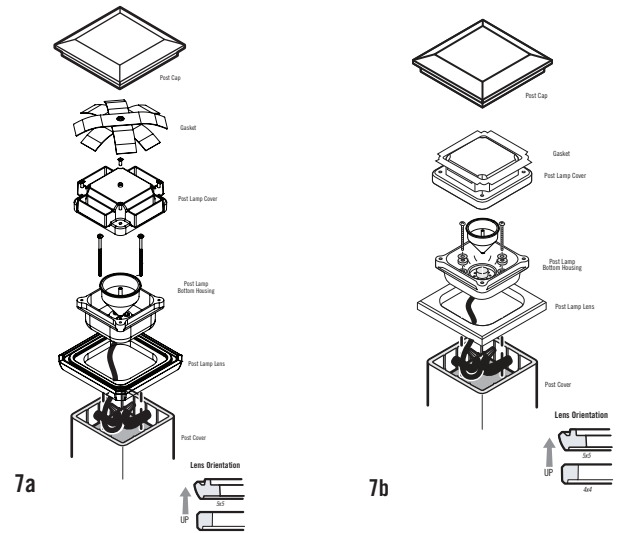
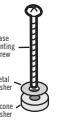

7a

7b

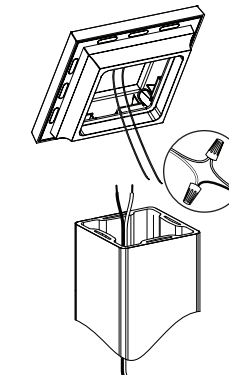

Lighted Island Cap Installation

The Lighted Island Cap is preassembled. Installation simply requires the wires to be properly connected and the unit placed onto the post.