

ATLANTIS RAIL Contact Information:

Atlantis Rail Systems

70 Armstrong Road
Plymouth, MA 02360

3900 Civic Center Drive

North Las Vegas, NV 89030

(800) 541-6829 or (508) 732-9191

(508) 732-9798

www.atlantisrail.com

RailEasy[™] Cable Railing Installation Instructions

Atlantis Rail's RailEasy[™] Cable Railing System is an easy to use cable railing product utilizing patented RailEasy[™] fittings. The compression fitting allows for installation and tensioning with simple hand tools. The following guide will take you step-by-step through the process of installing your RailEasy[™] Cable System, offering helpful tips and tricks along the way.



Table of Contents

Tools	1
Tips for a Successful Installation	2
RailEasy[™] Components	2
Additional Components	2
Straight Section - Preparation	3
Straight Section - Installing the Cable	5
Straight Section - Tensioning the Cable	6
Straight Section - Install Cover Nuts for Stud Assembly Only	8
Stair & Ramp Section - Preparation	8
Stair & Ramp Section - Installing the Cable	9
Stair & Ramp Section - Tensioning the Cable	10
Additional Components	11
RailEasy[™] Cable Railing System Specifications	12
RailEasy[™] Cable Railing System Part Numbers & Descriptions	12

Tools

Required & Recommended



Before you begin

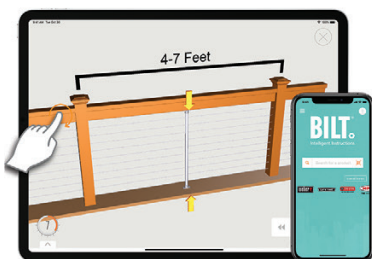

3D-GUIDED INTERACTIVE ASSEMBLY INSTRUCTIONS CAN BE FOUND IN BILT[®]
DOWNLOAD THE FREE APP



Tips for a Successful Installation

- Read the instructions completely before beginning the installation.
- Plan your railing project. Sketch your project with the actual measurements of your deck or balcony complete with post locations.
- Check carton(s) to determine part count is complete.
- Installation is best accomplished with two (2) people.
- Always wear personal protection equipment; safety glasses, work gloves, etc.
- Use care not to over-torque the screws. Pre-drilling is recommended.



ATLANTIS RAIL SYSTEMS PROVIDES A VARIETY OF MOUNTING OPTIONS FOR POSTS AND RAILS USED IN OUR SYSTEMS. PRODUCTS OF THIS NATURE REQUIRE THAT MOUNTING SURFACES ARE CONSTRUCTED TO BE CONSIDERED STRUCTURAL PER BUILDING CODE DEFINITION FOR THE SURFACE MATERIAL USED. STRUCTURAL INTEGRITY AND BUILDING CODE COMPLIANCE OF MOUNTING SURFACES ARE THE RESPONSIBILITY OF THE END USER AND / OR INSTALLER. THE USE OF ANY OF OUR MOUNTING METHODS ARE AT THE OPTION AND DECISION OF THE END USER AND / OR INSTALLER AND SHOULD BE SELECTED TO MATCH THE STRUCTURAL MATERIAL USED TO CREATE THE MOUNTING SURFACE.



ALWAYS REFER TO YOUR LOCAL BUILDING CODE OFFICIALS PRIOR TO INSTALLING ANY ATLANTIS RAIL SYSTEM TO ENSURE ALL CODE AND SAFETY REQUIREMENTS ARE MET. ATLANTIS RAIL SYSTEMS IS NOT RESPONSIBLE FOR IMPROPER OR NON-RECOMMENDED INSTALLATIONS.

RailEasy™ Components

	C0981-0204 C0981-1004	RailEasy™ Tensioner 5/32" - 2 Pack RailEasy™ Tensioner 5/32" - 10 Pack
	C0981-S024 C0981-S104	RailEasy™ Swivel End 5/32" - 2 Pack RailEasy™ Swivel End 5/32" - 10 Pack
	C0980-0004-2	RailEasy™ Stud Assembly 5/32" - 2 Pack
	S0981-P004	RailEasy™ Flush Fitting 5/32"
	C0980-R004-2	RailEasy™ Lag Stud 5/32" - 2 Pack

Additional Components



Acorn Nut Set



Deluxe Cover Nut Set



HandiSwage™
Cover Nut Sets



RailEasy™
Cable Sleeve

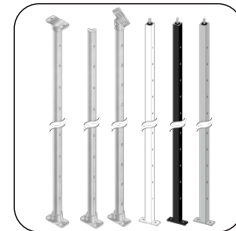

Cable Stabilizer Kits

Straight Section - Preparation

The infill for Atlantis Rail's RailEasy™ System is comprised of cable and a variety of fittings. The following section will show you how to install fittings on straight sections.



IF INSTALLING CABLE STABILIZERS, PLEASE REFER TO THE CABLE STABILIZER INSTALLATION INSTRUCTIONS.

Atlantis Rail offers a drilling template (part # C0988-1000) to aid in your installation process. Ask your Sales Representative for more information.

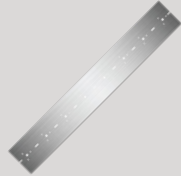

RailEasy™ Tensioner (C0981 Series) & RailEasy™ Swivel End (C0981-S Series)

Space and Install the Tensioners & Swivel Ends

Determine the number of cable runs you will need to maintain code compliance.



ATLANTIS RAIL REQUIRES SPACING YOUR CABLE AT 3" ON CENTER TO HELP AVOID ANY POTENTIAL BUILDING INSPECTION OR SAFETY ISSUES.

Using a square, find the center of the post face and draw a vertical line. Measure your spacing up from the mounting surface or top of the bottom rail to the underside of the top railing. Using the square, draw lines across the post face making sure they intersect with the center line you just drew (See Figure A). Repeat for each post. The drilling template makes this easier. This is for level sections only and always have the drilling template oriented to the single screw hole is facing up (See Figure B).

Next, place the center of a tensioner or swivel end on the intersection of each line and carefully mark the center of each screw hole (See Figure C). Remove and pre-drill the holes using a 1/8" drill bit. On level sections the concave angle adjustment space should be pointed down. Fasten tensioners or swivel ends using (3) #8 x 1-1/2" screws (supplied). Install on all end and corner posts using equal spacing through. When installing tensioners or swivels end on straight sections, make sure the recess in the base is facing downwards. This will help to hide the recess.



THE SWIVEL END MUST BE ACCOMPANIED BY A TENSIONING DEVICE ON THE OPPOSITE END OF THE CABLE RUN AND MAY BE USED IN PLACE OF A TENSIONER AT ONE END FOR RUNS LESS THAN 25 FEET.

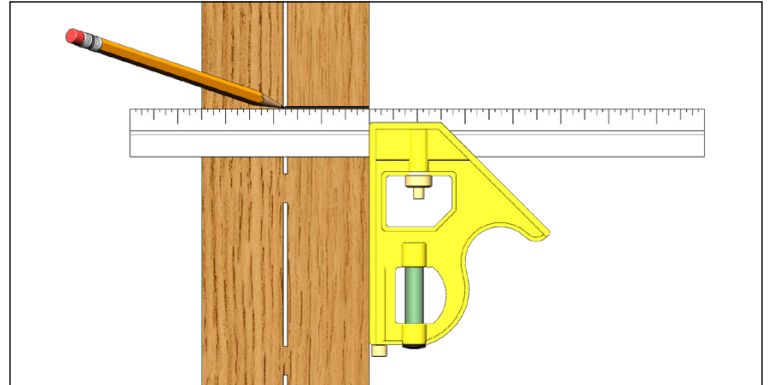

Figure A. Measure and mark both sides of every post at 3" on center.

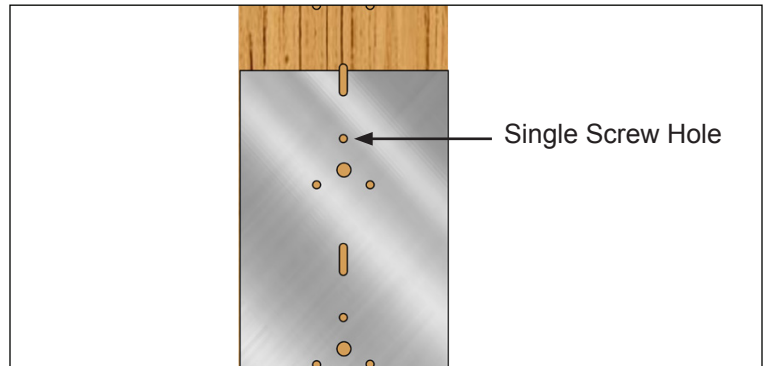

Figure B. Atlantis offers a drilling template to help you find your centers.

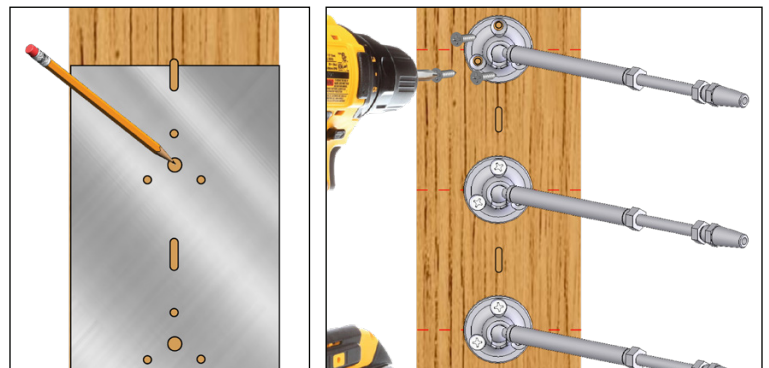

Figure C. Carefully mark the center of each screw hole. Pre-drill the holes using a 1/8" drill bit. Fasten tensioners using (3) #8 x 1-1/2" screws (supplied).

RailEasy™ Stud Assembly (C0980-0004-2)

The stud assembly is used in cable railing applications on straight runs. Using a 1/4" drill bit, drill through the post and install the stud assembly, fixing it to the back side (See Figure D). Tighten the locking nut to tension and cut off the excess thread to fit the Acorn Nut Set (standard). A Deluxe Cover Nut Set and HandiSwage™ Cover Nut Sets are also available for a desired finished look.

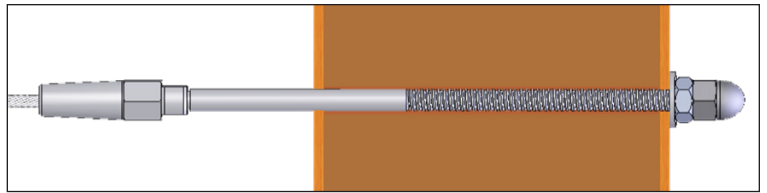

Figure D. Using a 1/4" drill bit, drill through the post and install the stud assembly.

RailEasy™ Flush Fitting (C0981-P004-2)

The flush fitting is designed to ease installation by eliminating the need for accurate measurement and swaging at one end of a cable run. You still use a RailEasy™ stud or tensioner on the other end of the cable run. When using the flush fitting on one end you will re-drill the back end of the post (See Figure E) with a 3/8" bit approximately 1-1/4" deep to accept the flush fitting. See additional instructions on page 6 for running cable using the flush fitting. Cover nut sets are sold separately.

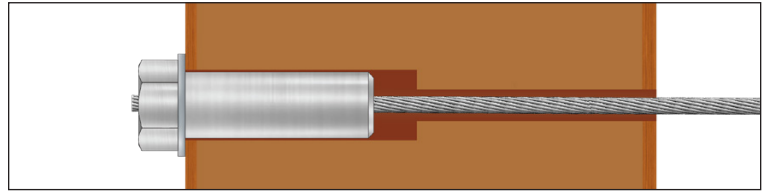

Figure E. Re-drill the back end of the post with a 3/8" bit to accept the flush fitting.

RailEasy™ Lag Stud (C0980-R004-2)

The lag stud is designed for use in short runs and must always be used with a RailEasy™ Tensioner at the opposite end of the cable run. With a 3/16" drill bit, drill approximately 1-5/8" deep to accept the lag stud (See Figure F). Using a 3/8" wrench, turn the lag stud until it is fully seated to the face of the post. These fittings are available with a right hand thread. The compression fitting holds the cable using simple hand tools. A left handed thread RailEasy™ Lag Stud is also available (part # S0980-L004).

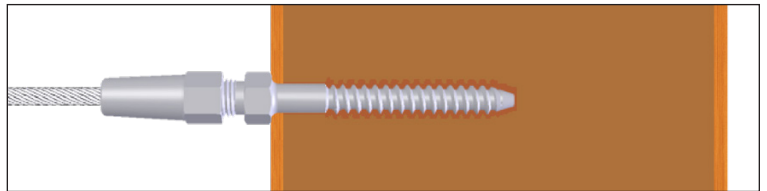

Figure F. With a 3/16" drill bit, drill approximately 1-5/8" deep to accept the lag stud. Use a 3/8" open wrench on the flats of the stud to install into a wood post.



THE FLUSH FITTING AND LAG STUD MUST BE ACCOMPANIED BY A TENSIONING DEVICE ON THE OPPOSITE END OF THE CABLE RUN AND MAY BE USED IN PLACE OF A TENSIONER AT ONE END FOR RUNS LESS THAN 25 FEET.

Cable Stabilizer Kits

More information is available in the Additional Components section found towards the end of these installation instructions. Refer to the Cable Stabilizer Kit Installation Instructions for detailed information on how to properly install cable stabilizers.



THE CABLE STABILIZER KIT CANNOT BE USED TO REPLACE THE USE OF SUBSTANTIAL MID POSTS AND SHOULD NEVER BE USED IN SPANS OVER 7'

RailEasy™ Cable Sleeve (C0915-0438)

More information is available in the Additional Components section found towards the end of these installation instructions. Refer to the Cable Sleeve installation instructions for detailed information on how to properly install cable sleeves.

Straight Section - Installing the Cable

Atlantis Rail offers cable cutters (part # C0989-00HD) to aid in the cutting of 5/32" cable. It is important that you use sharp tools to cut the cable, as a dull tool will splay it. Ask your Atlantis Rail Sales Representative for more information.



ALWAYS USE WORK GLOVES AND WEAR SAFETY GLASSES TO PROTECT YOUR HANDS AND EYES WHILE WORKING WITH CABLE. DO NOT OVER-TENSION.

RailEasy™ Tensioner (C0981 Series)

Measure & Run the Cable

With the tensioners installed (See Figure G), begin by extending the threaded stud outward a minimum of 3/4" for the first 20 feet plus 1/4" for each additional 10 feet. Insert the cable into the receiver cone, push and twist the cable opposite the lay of the wire strands. The cable should slide into the receiver cone until approximately 3/16" past the bottom of the wedge (See Figure H). Fully tighten the receiver cone onto the threaded stud using 7/16" and 3/8" open wrenches. Upon doing this, the wedge will crimp down on the cable and hold it in place. With the cable installed in one tensioner, pull the cable to the opposite tensioner. Pull the cable tight to the tensioner and cut it (See Figure I). Using the first run as a guide, cut the remaining runs to the same length. This will ensure uniformity among the tensioners. Thread the cable through each mid post and install the cable into the opposite tensioner using the same process as before.

RailEasy™ Stud Assembly (C0980-0004-2)

With the stud assembly installed into the post and required space to tension, insert the cable into the receiver cone, push and twist the cable opposite the lay of the wire strands. The cable should slide into the receiver cone until approximately 3/16" past the bottom of the wedge (See Figure H). Fully tighten the receiver cone onto the threaded stud using 7/16" and 3/8" open wrenches. Upon doing this, the wedge will crimp down on the cable and hold it in place. Pull the cable tight to the tensioner end of the stud assembly and cut it (See Figure J).

The stud assembly comes standard with the Acorn Nut Set but the Deluxe Cover Nut Set and HandiSwage™ Cover Nuts Sets are also available for the desired finished look.

RailEasy™ Swivel End (C0981-S Series)

The swivel end must be used in conjunction with a RailEasy™ Tensioner in order to tension the cable. Follow the same process as above to cut and install the cable (See Figure K). A swivel end may be used in place of a tensioner at one end for runs less than 25 feet.

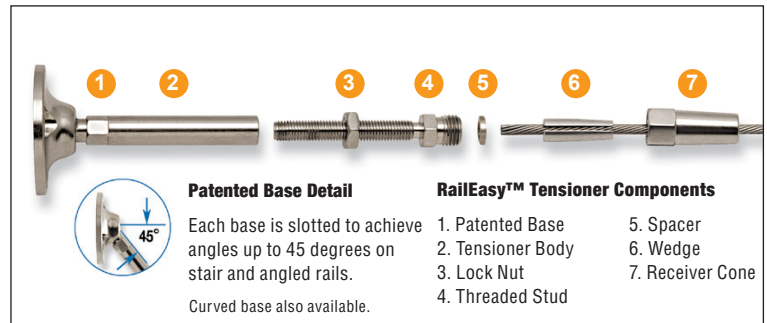

Figure G. Exploded view of the RailEasy™ Tensioner for easy identification of each component.

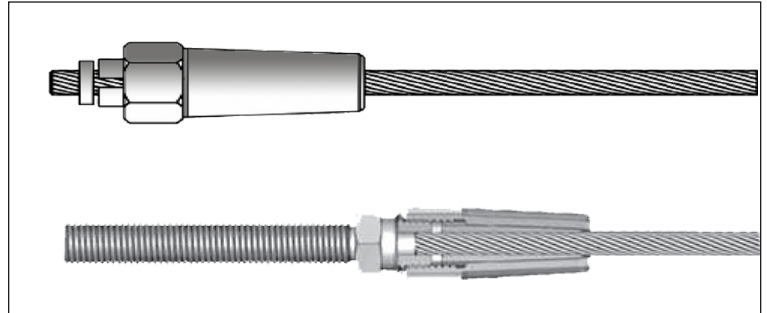

Figure H. Cutaway view of the RailEasy™ Tensioner

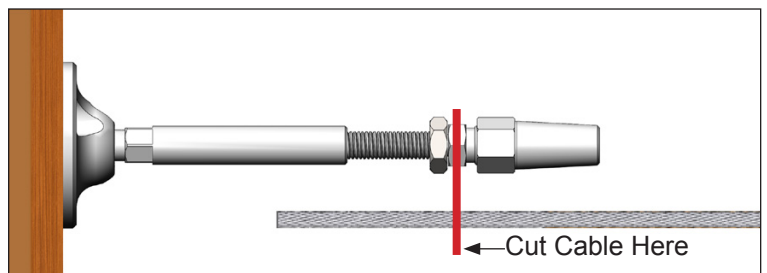

Figure I. Pull the cable tight to the tensioner, mark and cut the cable at the hex flats on the threaded stud.

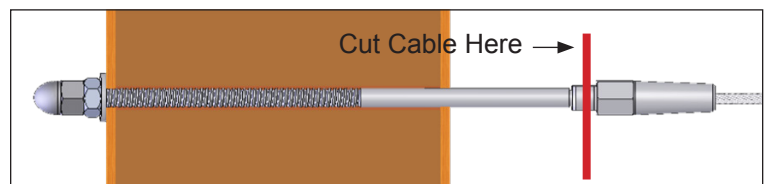

Figure J. Pull the cable tight to the tensioner end of the stud assembly and cut it.

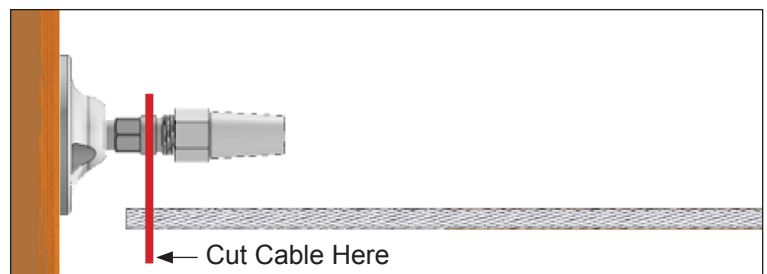

Figure K. Pull the cable tight to the tensioner, mark and cut the cable at the hex flats on the threaded stud.

RailEasy™ Flush Fitting (C0981-P004-2)

If using the HandiSwage™ Flush Fitting measure the entire span from outside to outside cable run posts and add 2 inches beyond the post at the opposite end and cut your cable to that length. Re-drill the back end of the post with a 3/8" bit approximately 1-1/4" deep to accept the flush fitting (See Figure L). Run your cable to the opposite post where you have drilled the post to accept the flush fitting, going through all mid posts. At the opposite end, hold the cable near to the tip of the flush fitting to support and guide it in. Push in and turn clockwise to avoid the wire from "splaying" (See Figure M).



PULL THROUGH AT LEAST 1" OF EXCESS WIRE FROM THE FITTING.

When installing the flush fitting in the post pull the wire forward to seat the fitting and make sure it does not slip. Tension the cable at the opposite post before cutting the cable. Using a hacksaw or cutting disc, cut the cable straight and even against the fitting (See Figure N). Using a rubber mallet, lightly tap on the desired cover nut sets until flush with the post. Cover nut sets are sold separately (See Figure O).

RailEasy™ Lag Stud (C0980-R004-2)

For the lag stud follow the same process as before to install the cable (See Figure P). The lag stud like the swivel end and flush fitting is the terminal end of the cable run and must be accompanied with a tensioning device on the other end of the cable run. Pull the cable tight to the lag stud end and cut it. A lag stud may be used in place of a tensioner at one end for runs less than 25 feet.

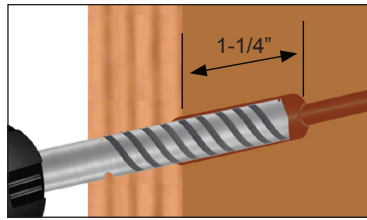

Figure L. (Left) Re-drill the back end of the post with a 3/8" bit approximately 1-1/4" deep to accept the flush fitting.

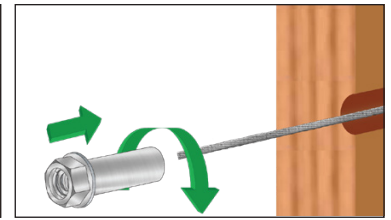

Figure M. (Right) hold the cable near to the tip of the flush fitting to support and guide it in. Push in and turn clockwise to avoid the wire from "splaying".

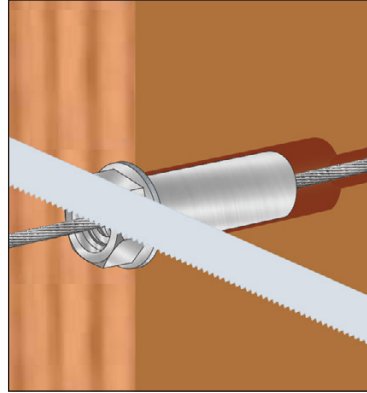

Figure N. (Left) Tension the cable at the opposite post. Using a hacksaw or cutting disc, cut the cable straight and even against the fitting.

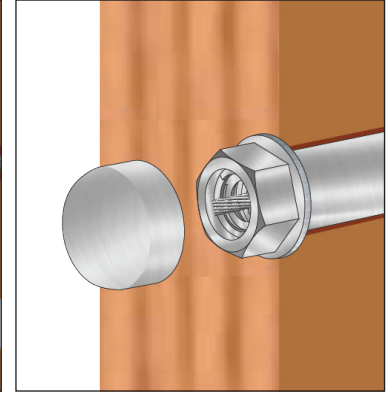

Figure O. (Right) Using a rubber mallet lightly tap on the desired cover nut sets until flush with the post. Cover nut sets are sold separately.

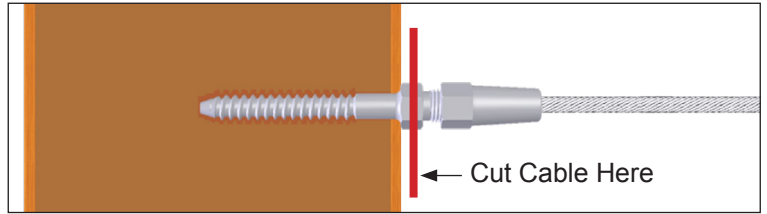

Figure P. Pull the cable tight to the lag stud end and cut it.

Straight Section - Tensioning the Cable



BEFORE TENSIONING ANY OF THE CABLES, IT IS IMPORTANT TO BE SURE THAT THE FRAME FOR THE INFILL IS COMPLETED.

Make sure the posts are installed securely and in accordance with the manufacturers' recommended installation procedures. Install all top and intermediate rails. The posts will deflect beyond allowable limits if you attempt to tension the cables on an incomplete guard frame. Before tensioning with tools, hold the stud fittings firm and tension the nuts of the system by hand until all cables are snug.

RailEasy™ Tensioner (C0981 Series)

Tension the Center Cable

Begin with the center run of cable. Using a 3/8" open wrench, hold the threaded stud in place and rotate the tensioner body with a 5/16" open wrench. Tension each side equally until taut. **Do NOT over-tension.** Over-tensioning will cause posts to deform and deflect. When all cable runs are properly tensioned, tighten the lock nuts down to maintain tension.

When tensioning, it is important to begin with the center run of cable and alternate working above and below the center, much like tightening the lug nuts on a tire (See *Figure Q*). This will help to ensure that your posts don't deflect during tensioning. It will also help tension equally through. Continue tensioning all the cables in this same fashion until all cables are tensioned.

RailEasy™ Stud Assembly (C0980-0004-2)

With the stud assembly installed into the post and required space to tension, insert the cable into the receiver cone, push and twist the cable opposite the lay of the wire strands. The cable should slide into the receiver cone until approximately 3/16" past the bottom of the wedge. Fully tighten the receiver cone onto the threaded stud using 7/16" and 3/8" open wrenches. Upon doing this, the wedge will crimp down on the cable and hold it in place. Pull the cable tight to the tensioner end of the stud assembly and cut it.

The stud assembly comes standard with the Acorn Nut Set but the Deluxe Cover Nut Set and HandiSwage™ Cover Nuts Sets are also available for the desired finished look.

RailEasy™ Swivel End (C0981-S Series)

If using a swivel end, the opposite end of the cable assembly requires a tensioning device. The swivel end should be installed in the post and have cable installed in it. Follow the tensioning directions for the RailEasy™ Tensioner or Stud Assembly to tension the other side of the swivel end cable run. A swivel end may be used in place of a tensioner at one end for runs less than 25 feet.

RailEasy™ Flush Fitting (C0981-P004-2)

If using a flush fitting, the opposite end of the cable assembly requires a tensioning device. The flush fitting should be installed in the post and have cable installed in it. Follow the tensioning directions for the RailEasy™ Tensioner or Stud Assembly to tension the other side of the flush fitting cable run. A flush fitting may be used in place of a tensioner at one end for runs less than 25 feet.

RailEasy™ Lag Stud (C0980-R004-2)

If using a lag stud, the opposite end of the cable assembly requires a tensioning device. The lag stud should be installed in the post and have the cable installed in it. Follow the tensioning directions for the RailEasy™ Tensioner or Stud Assembly to tension the other end of the lag stud cable run. A lag stud may be used in place of a tensioner at one end for runs less than 25 feet.

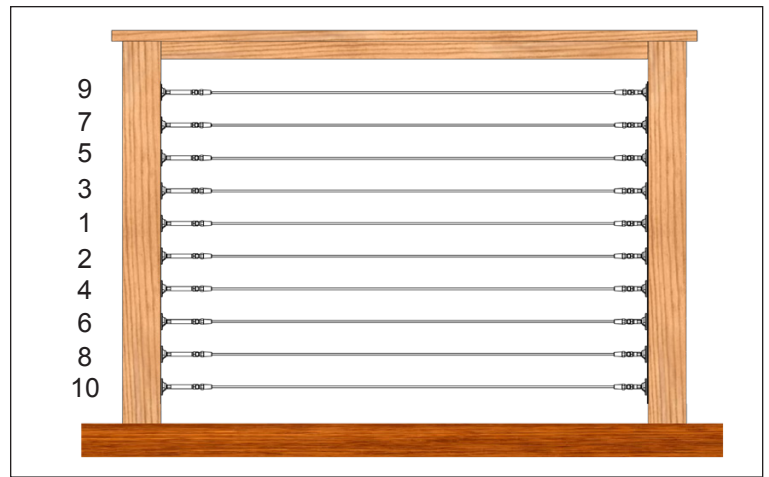

Figure Q. Tensioning Diagram - Begin with the center run of cable and alternate working above and below until cables are tight.

Straight Section - Installing Cover Nuts for Stud Assembly Only

Acorn Nut Set (C0308-UF07-2)

The Acorn Nut Set (See *Figure R*) are designed for use with RailEasy™ Stud Assemblies and are perfect for cable railing systems where “through-post” hardware is desired for minimal obstruction). Affix the stainless steel acorn nut set to the end of a swage stud for a finished look. The Acorn Nut Set comes with a stainless steel nut and washer in packs of 2.

- 1) With the cables tensioned, it's time to install the cover nuts. This is accomplished in just three easy steps, and you just did one of them!
- 2) Using a hacksaw, cut the remaining shank off flush with the tensioning nut.
- 3) Then place the cover nut over the assembly until it is flush with the post (See *Figure S*).

In addition to the Acorn Nut Set, Atlantis Rail offers a Deluxe Cover Nut Set (part # C0307-U007-2) and HandiSwage™ Cover Nut Sets (part # C0309 Series). More information is available in the Additional Components section found towards the end of these installation instructions.



Figure R. Acorn Nut Set.

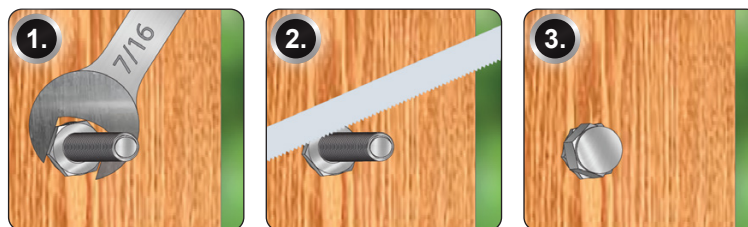

Figure S. The HandiSwage™ Cover Nut Set installs in just 3 easy steps: tighten, cut and cover.

Stair & Ramp Section - Preparation

RailEasy™ Tensioner (C0981 Series)

Atlantis Rail offers a swiveling component to accommodate stairs, ramps, and other angled cable sections. This is the RailEasy™ Tensioner (part # C0981 Series). The RailEasy™ Tensioner is installed with three (3) #8 x 1-1/2" wood screws and swivels up to 45 degrees.

Measure and Mark your Posts

As in the previous section, begin by determining the number of cables you need to maintain code compliance.



ATLANTIS RAIL REQUIRES SPACING YOUR CABLE AT 3" ON CENTER TO HELP AVOID ANY POTENTIAL BUILDING INSPECTION OR SAFETY ISSUES.

As before, find the center of your posts and draw a vertical line. Snap a chalk line parallel to the slope of the stairs at the height of your lowest cable run. Measure for your other cables 3" on center perpendicular to that line (See *Figure T*). Snap a chalk line for each cable run. Using a carpenter's square, transfer a line to the inside post face to find the center of your cable (See *Figure U*). Where this line intersects the vertical line is the center point for your cable.

Use Your Fittings as a Guide

On the end posts, place the center of your tensioner on the marks made in the previous section. Carefully mark and pre-drill the centers of the fastener holes using a 1/8" drill bit. The RailEasy™ Tensioner base uses three (3) #8 screws. When installing tensioners on stairs make sure the notch is facing vertical allowing the 45° of motion up or down.

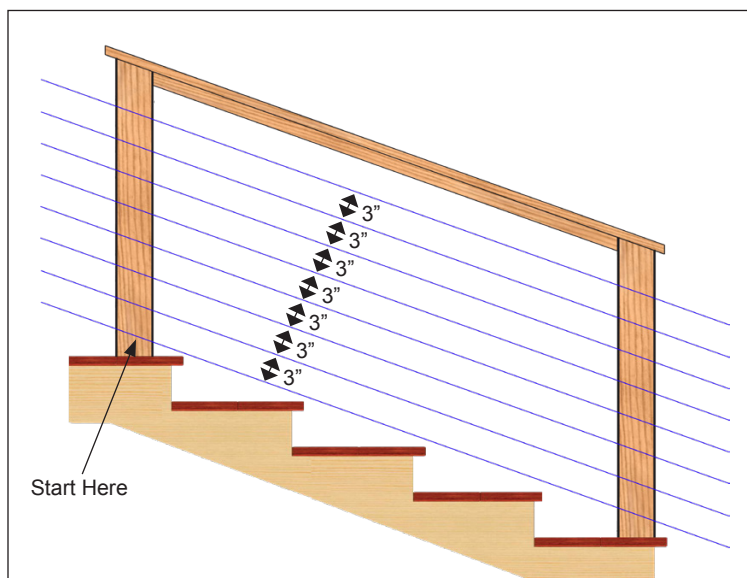

Figure T. Measure perpendicularly from the chalk line to find the center line of your cables.

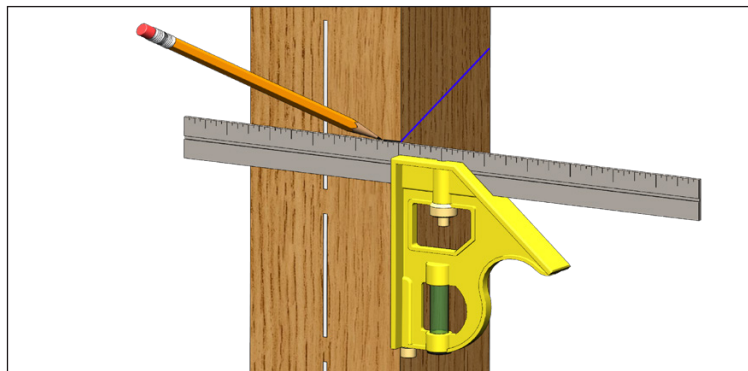

Figure U. Using a carpenter's square, transfer the chalk line to the inside face of the post. The intersection of this line and the vertical will mark your center.



THE FLUSH FITTING AND LAG STUD MUST BE ACCOMPANIED BY A TENSIONING DEVICE ON THE OPPOSITE END OF THE CABLE RUN AND MAY BE USED IN PLACE OF A TENSIONER AT ONE END FOR RUNS LESS THAN 25 FEET.

Stair & Ramp Section - Installing the Cable

RailEasy™ Tensioner (C0981 Series)

Measure & Run the Cable

With the tensioners installed (See *Figure V*), begin by extending the threaded stud outward a minimum of 3/4" for the first 20 feet plus 1/4" for each additional 10 feet. To insert the cable into the receiver cone, push and twist the cable opposite the lay of the wire strands. The cable should slide into the receiver cone until approximately 3/16" past the bottom of the wedge (See *Figure W*). Fully tighten the receiver cone onto the threaded stud using 7/16" and 3/8" open wrenches. Upon doing this, the wedge will crimp down on the cable and hold it in place. With the cable installed in one tensioner, pull the cable to the opposite tensioner. Pull the cable tight to the tensioner and cut it (See *Figure X*). Using the first run as a guide, cut the remaining runs to the same length. This will ensure uniformity among the tensioners. Thread the cable through each mid post and install the cable into the opposite tensioner using the same process as before.

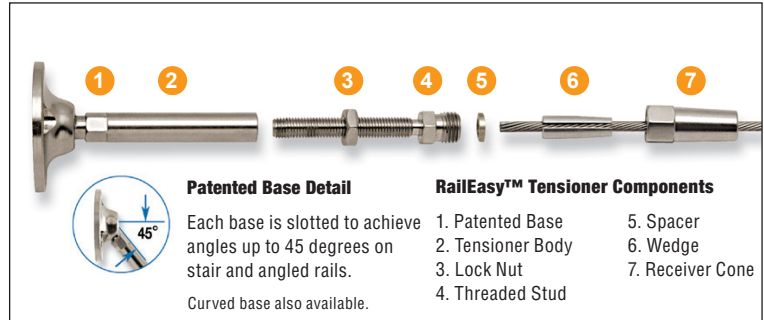

Figure V. Exploded view of the RailEasy™ Tensioner for easy identification of each component.

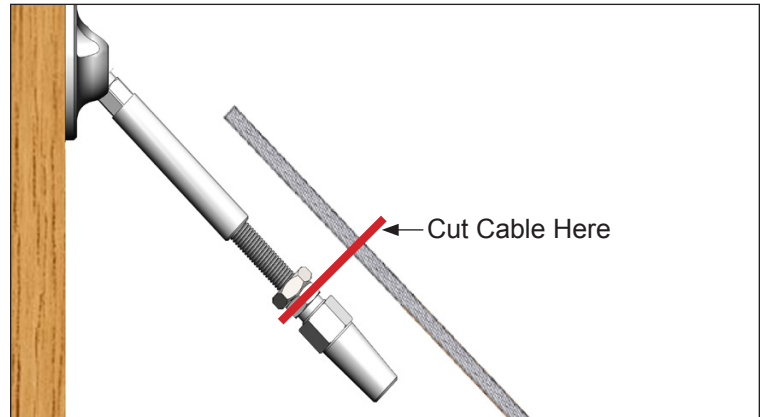

Figure X. Pull the cable tight to the tensioner, mark and cut the cable at the hex flats on the threaded stud.

RailEasy™ Swivel End (C0981-S Series)

The swivel end must be used in conjunction with a RailEasy™ Tensioner in order to tension cable. Follow the same process as above to cut and install the cable (See *Figure Y*). A swivel end may be used in place of a tensioner at one end for runs less than 25 feet.

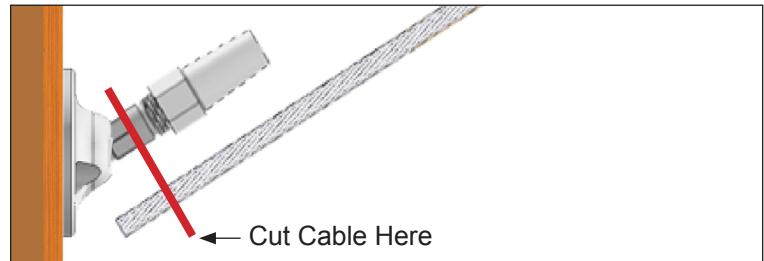

Figure Y Pull the cable tight to the tensioner, mark and cut the cable at the hex flats on the threaded stud.



BEFORE TENSIONING ANY OF THE CABLES, IT IS IMPORTANT TO BE SURE THAT THE FRAME FOR THE INFILL IS COMPLETED.

Make sure the posts are installed securely and in accordance with the manufacturers' recommended installation procedures. Install all top and intermediate rails. The posts will deflect beyond allowable limits if you attempt to tension the cables on an incomplete guard frame.

RailEasy™ Tensioner (C0981 Series)

Tension the Center Cable

Before tensioning with tools, hold the threaded stud firm and rotate the tensioner body by hand until all cables are snug.

Beginning with the center run of cable, hold the threaded stud firm using a 3/8" wrench. Using a 5/16" open wrench, rotate the tensioner body to tension the cable (See Figure Z). Turn the body three or four full rotations until cable is snug. Don't worry if this cable moves a little, we will come back around to it later. Tension cable equally from both ends of each cable span. Tighten Lock Nut to secure tension.

For additional instructions refer to the RailEasy™ Tensioner installation instructions.

Tension the Remaining Cables

Alternate tensioning the cables from center, working above and below the center cable as if tightening the lug nuts on a tire (See Figure AA). Rotate the body three or four full rotations or until cable is snug. You will notice as you tension, the cables surrounding it will slacken. When this begins happening, stop tensioning and move onto the next cable.

Make Final Adjustments

Go back to the center cable and re-tighten the cables until all are tight and relatively equal in tension. You may find that you need to do this three or four times getting down to even a quarter turn of the tensioner body each time. Tension from both sides when necessary. Add "Non-Acidic" Silicone Sealant to open tip of Receiver Cone in harsh environments.



ALWAYS USE WORK GLOVES AND WEAR SAFETY GLASSES TO PROTECT YOUR HANDS AND EYES WHILE WORKING WITH CABLE. DO NOT OVER-TENSION.

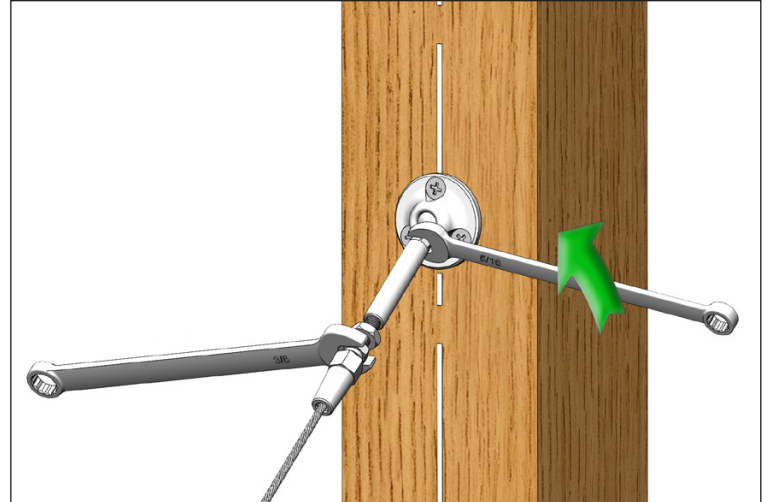

Figure Z. Hold the tensioner terminal still with a 3/16" wrench and using a 5/16" open wrench, rotate tensioner body to tension.

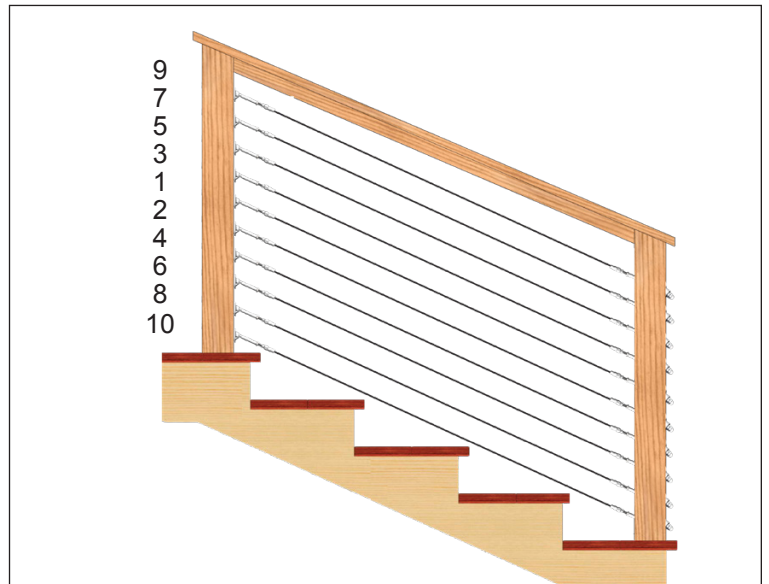

Figure AA. Tensioning Diagram - Begin with the center run of cable and alternate working above and below until cables are tight.

Additional Components

Acorn Nut Set*



C0308-UF07-2

Designed for use with RailEasy™ Stud Assembly. This set is perfect for cable railing systems where “through post” hardware is desired for minimal obstruction. Affix the stainless steel acorn nut set to the end of a stud assembly for a finished look (See *Figure AB*). Finish: Polished Stainless Steel. Available in 2 packs.

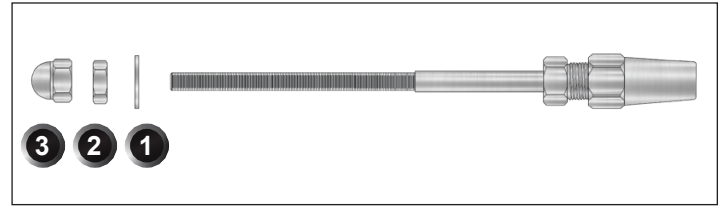

Figure AB Acorn Nut Set assembly diagram - 1) Stainless Steel Washer, 2) Stainless Steel Nut & 3) Stainless Steel Acorn Nut.

* The Acorn Nut Set comes with the RailEasy™ Stud Assembly or sold separately.

Deluxe Cover Nut Set



C0307-U007-2

Designed for use with the RailEasy™ Stud Assembly. The Cover Nut Set is perfect for cable railing systems where “through-post” hardware is desired for minimal obstruction. Affix to the end of the stud assembly for a finished look (See *Figure AC*). Finish: Polished Stainless Steel. Available in 2 packs.

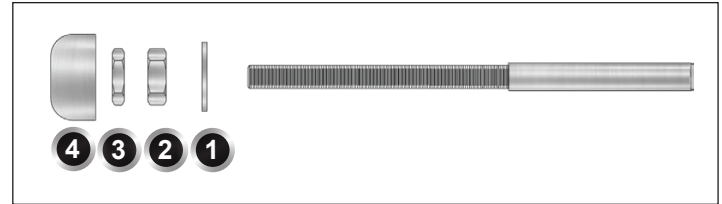

Figure AC. Deluxe Cover Nut Set assembly diagram - 1) Stainless Steel Washer, 2) Stainless Steel Nut 3) Stainless Steel Lock Nut & 4) Stainless Steel Deluxe Cover. RailEasy™ Stud Assembly not included.

HandiSwage™ Cover Nut Sets



C0309 Series

Designed for use with RailEasy™ Stud Assembly. Cover Nut Sets are perfect for cable railing systems where “through-post” hardware is desired for minimal obstruction. Affix to end of stud assembly for a finished look (See *Figure AD*). Finishes: White, Light Brown, Dark Brown, Metallic Silver and Black. Available in 10 packs.

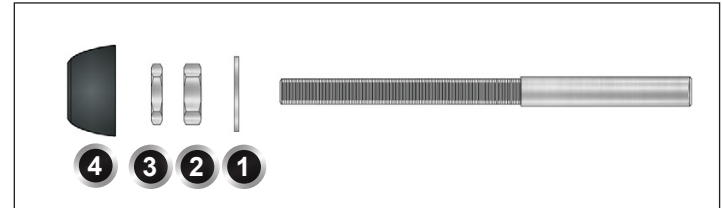
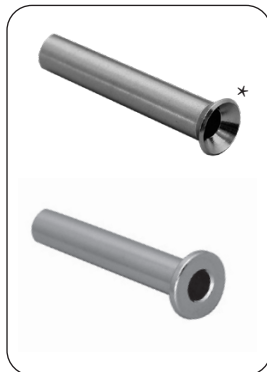

Figure AD. HandiSwage™ Cover Nut Set assembly diagram - 1) Stainless Steel Washer 2) Stainless Steel Nut 3) Stainless Steel Lock Nut & 4) HandiSwage™ Cover. RailEasy™ Stud Assembly not included.

RailEasy™ Cable Sleeve



C0915-0438* &
C0915-0438-F

The RailEasy™ Cable Sleeve is designed to protect your wood, vinyl or composite posts from chafing and incidental damage from cable rubbing around the outside of your mid post cable holes. It can also be used to accommodate angles up to 90 degrees (double posts required) and stairways coming off a straight run (See *Figures AE and AF*). These sleeves are made from grade 316L stainless steel for corrosion resistance and durability.

For the mid posts, use a 1/4” drill bit and drill completely through the posts. Again, drilling from either side of the post and meeting in the middle will help you hit your centers and make for a neater installation. The cable will need to run through this hole without kinking or bending.

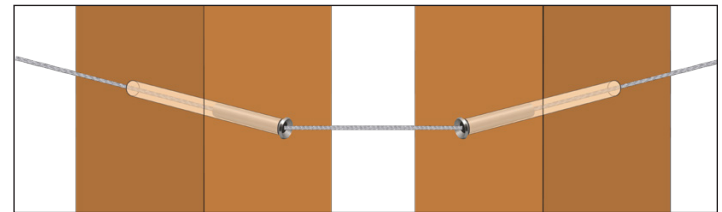

Figure AE. Cable Sleeve Diagram - Accommodating angles up to 90 degrees. Doubling up on corner posts is required.

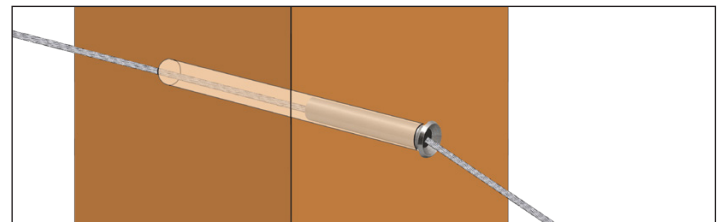
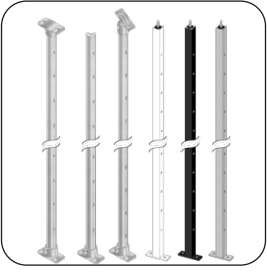

Figure AF. Cable Sleeve Diagram - Accommodating a stairway coming off a straight run.

* Use the RailEasy™ Cable Sleeve (part # C0915-0438) for wood posts (pictured). Use the RailEasy™ Cable Sleeve Flush Mounted (part # C0915-0438-F) for vinyl and composite sleeves.

Cable Stabilizer Kits



Cable Stabilizer Kits
(S0950-0060, S0950-0061,
S0950-S060, A0908-BK60,
A0908-WH60 &
A0908-MT60)

Cable Stabilizers are designed specifically for use where post to post measurement spans over 4'. It enables you to adapt longer spans to code compliance by stabilizing the deflection of cable between posts. Each stabilizer comes with a 36" or 42" stanchion pre-drilled to work with our standard 3" spacing. In most cases, stanchions must be field cut at both ends for an accurate fit.

The cable stabilizer cannot be used to replace the use of substantial mid posts and should never be used in spans over 6'. The cable stabilizer includes fasteners.

For detailed instructions refer to the Cable Stabilizer Installation Instructions.

RailEasy™ Cable Railing System Specifications

The RailEasy™ Cable Railing System combines the natural beauty of wood with the streamlined look of patented RailEasy™ fittings and cable. These fittings and cable are made from the extremely corrosion resistant type 316L stainless steel to add years of long term value. Atlantis Rail does not provide the wood, only the cable, hardware and optional vinyl components. A bottom rail is optional.

Straight Sections

Atlantis Rail offers standard rail heights of 36" or 42" for straight sections.

Stair Sections

Rail height for stair sections is available in 36" only.



RAILING HEIGHTS ARE OFFERED IN THESE DIMENSIONS DUE TO NATIONWIDE BUILDING CODES. HOWEVER, ATLANTIS RAIL CAN SUPPLY CUSTOM HEIGHTS/LENGTHS UPON REQUEST.

Between Post Lengths

Atlantis Rail recommends staying within 4' section lengths to maintain structural integrity. If section lengths exceed 4', Atlantis Rail offers a Cable Stabilizer Kit to minimize cable deflection.

Cable Spacing

The cable is spaced on posts at 3" on-center to comply with nationwide building codes.

RailEasy™ Cable Railing System Part Numbers & Description

Components

Product	Description	Dimensions	Fasteners	Notes
C0978-4025	5/32" Cable, 25ft. Spool	5/32" 1x19 316 stainless steel cable	--	--
C0978-4100	5/32" Cable, 100ft. Spool	5/32" 1x19 316 stainless steel cable	--	--
C0978-4500	5/32" Cable, 500ft. Spool	5/32" 1x19 316 stainless steel cable	--	--
C0981-0204	RailEasy™ Tensioner (2 Pack)	5.40" length 1/4"-28 RH thread	(3) #8 x 1-1/2"	Adjustable
C0981-1004	RailEasy™ Tensioner (10 Pack)	5.40" length 1/4"-28 RH thread	(3) #8 x 1-1/2"	Adjustable
C0981-S024	RailEasy™ Swivel End (2 Pack)	2.26" length 1/4"-28 RH thread	(3) #8 x 1-1/2"	Adjustable
C0981-S104	RailEasy™ Swivel End (10 Pack)	2.26" length 1/4"-28 RH thread	(3) #8 x 1-1/2"	Adjustable
S0982-0004	RailEasy™ Tensioner Round	5.50" length 1/4"-28 RH thread	3/16" rivet	Adjustable
S0982-S004	RailEasy™ Swivel End Round	2.30" length 1/4"-28 RH thread	3/16" rivet	Adjustable
C0981-P004-2	RailEasy™ Flush Fitting	5/32" 1.42" length	--	--
C0980-0004-2	RailEasy™ Stud Assembly	4.50" length 1/4"-28 RH thread	--	--
C0980-R004-2	RailEasy™ Lag Stud (2 Pack)	2.25" length	--	--

C0915-0438	RailEasy™ Cable Sleeve (10 Pack)	1.500" length .190" ID, .250" OD	--	--
C0915-0438-F	RailEasy™ Cable Sleeve (10 Pack)	1.500" length .190" ID, .250" OD	--	Flush Mounted
C0309-WH02-10	HandiSwage™ Cover Nut Set (10 Pack)	.420" length .690" OD (White)	--	1/4"-28 RH thread UNF
C0309-LB02-10	HandiSwage™ Cover Nut Set (10 Pack)	.420" length .690" OD (Light Brown)	--	1/4"-28 RH thread UNF
C0309-BR02-10	HandiSwage™ Cover Nut Set (10 Pack)	.420" length .690" OD (Dark Brown)	--	1/4"-28 RH thread UNF
C0309-BK02-10	HandiSwage™ Cover Nut Set (10 Pack)	.420" length .690" OD (Black)	--	1/4"-28 RH thread UNF
C0309-MT02-10	HandiSwage™ Cover Nut Set (10 Pack)	.420" length .690" OD (Metallic Silver)	--	1/4"-28 RH thread UNF
C0308-UF07-2	Acorn Nut Set (2 Pack)	.674" complete assembly	--	1/4"-28 RH thread UNF
C0307-U007-2	Deluxe Cover Nut Set (2 Pack)	.400" length .750" OD	--	1/4"-28 RH thread UNF
A0908-BK60	Aluminum Cable Stabilizer Kit	42" Length Aluminum	--	Black powder coat finish
A0908-WH60	Aluminum Cable Stabilizer Kit	42" Length Aluminum	--	White powder coat finish
S0950-0060	Cable Stabilizer Kit	42" Length 316L Stainless Steel	--	--
S0950-S060	Cable Stabilizer Stair Kit	42" Length 316L Stainless Steel	--	--
S0950-0061	Cable Stabilizer	42" Length 316L Stainless Steel	--	--
C0988-0000	RailEasy™ Installation Tools	--	--	White Vinyl
E0113-HG00	After Swage Gauge	--	--	Included with hand swager
C0988-1000	RailEasy™ Drill Template	--	--	3" on center
C0989-00HD	RailEasy™ Cable Cutter	--	--	--
E0114-0000	Cable Grip Pad (3 Pack)	--	--	--