

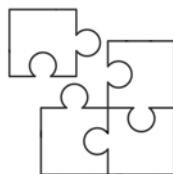

LINX™

SIMPLIFIED PERGOLA SYSTEM



ASSEMBLY INSTRUCTIONS

PARTS

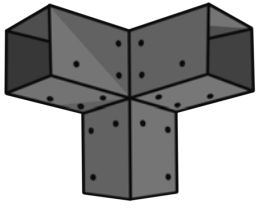

TRIFIT

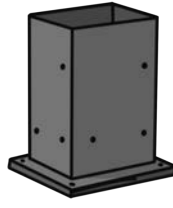

UNIFIT



FASTENER

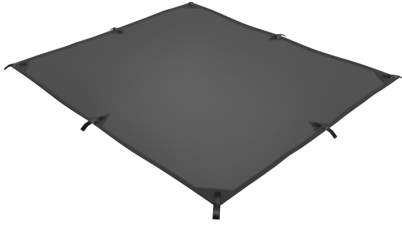

SUNSHADE

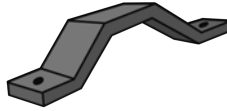

SIDE
BRACKET



CORNER
BRACKET

SUGGESTED TOOLS



DRILL

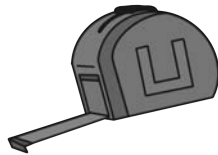

TAPE MEASURE



LEVEL



LADDER

RECOMMENDATIONS

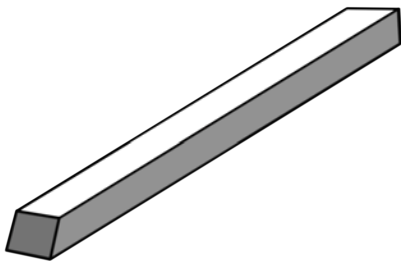

STRAIGHT, DRY WOOD
(SOLD SEPARATELY)

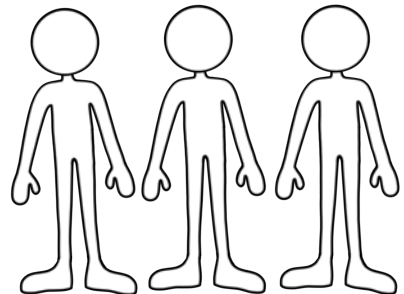

3 ADULTS FOR ASSEMBLY

IMPORTANT – CAUTION

- Wear personal protective equipment (PPE), including eye protection and gloves.
- It is the responsibility of the installer to meet all local building codes and permit requirements.
- LINX and its distributors shall not be held liable for improper or unsafe installations.
- Posts must always be properly secured to the substrate:
 - For deck installation the posts must be tied to the main framing structure via lag bolts (sold separately).
 - For concrete installation the posts must utilize a metal base plate (LINX Unifit or similar) permanently affixed to sound, uncracked concrete.
 - For soil installation of posts, 2 options:
 1. Utilize post spikes, sold by others. Follow spike manufacturer's instructions.
 2. Set in concrete, buried to a depth of at least 6" below the frost line.
- Post securing hardware is NOT included. Consult your local building permit office for recommendations.
- Do not leave partially assembled structure unattended.
- Do not leave fully assembled structure unattended without posts permanently attached to the ground.
- Do not assemble or install your structure during foul weather, including rain, lightning or high winds.
- Remove Sunshades and Hammocks during high winds and heavy snowfall.

NOTES

- Touch up paint for the LINX Simplified Pergola System is Rust-Oleum® Satin Canyon Black #249844, available at many local paint retailers.
- After removing LINX instructions, parts and fasteners from the LINX box, flatten the box and use it as a protective barrier between the LINX part and the ground to prevent scratches.

FOR QUESTIONS & SUPPORT

WILD HOG PRODUCTS
P.O. Box 1396
Healdsburg, CA 95448

CONTACT

1-888-HOGINFO
info@wildhogproducts.com
www.linxpergola.com

STEP 1 LAY OUT THE PARTS FOR THE TOP

- 4 wood posts + 4 TriFits, laid out in a square shape.
- Place flattened TriFit boxes between Linx parts and the ground to protect all surfaces.
- Measure parallel posts to ensure equal lengths. Trim with saw as necessary.

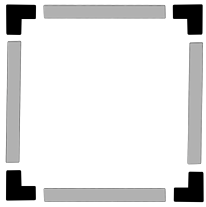

Top View

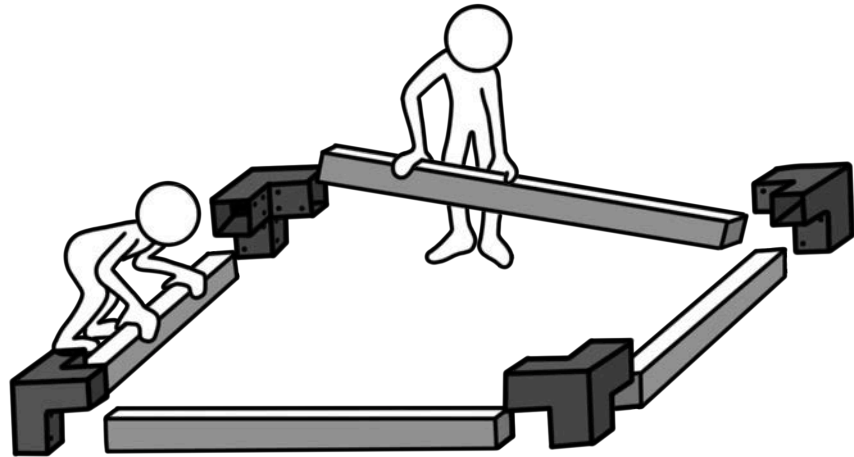

STEP 2 CREATE TWO 'C' SHAPE ENDS

- Selecting 2 parallel posts, slide the TriFits on both ends of each post. Do not use screw fasteners yet.

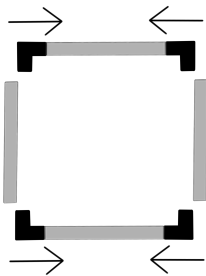

Top View

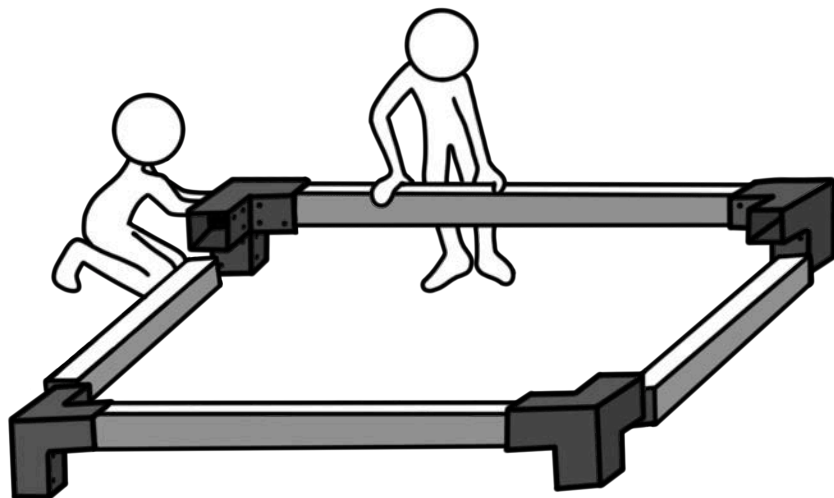

STEP 3 CREATE LARGE 'U' SHAPE

- Insert remaining 2 loose posts into each side of the 'C' end.
- Do not use screw fasteners yet.

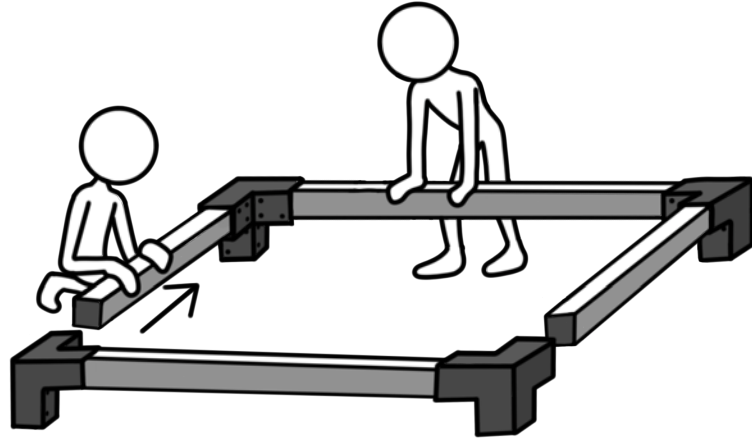
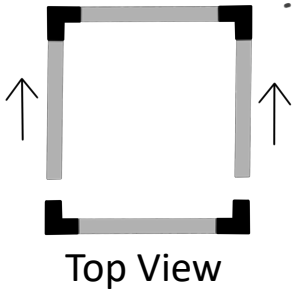

STEP 4 ATTACH 'C' END TO COMPLETE SQUARE

- Raise posts off ground and slide TriFits onto post.
- Do not use screw fasteners yet.

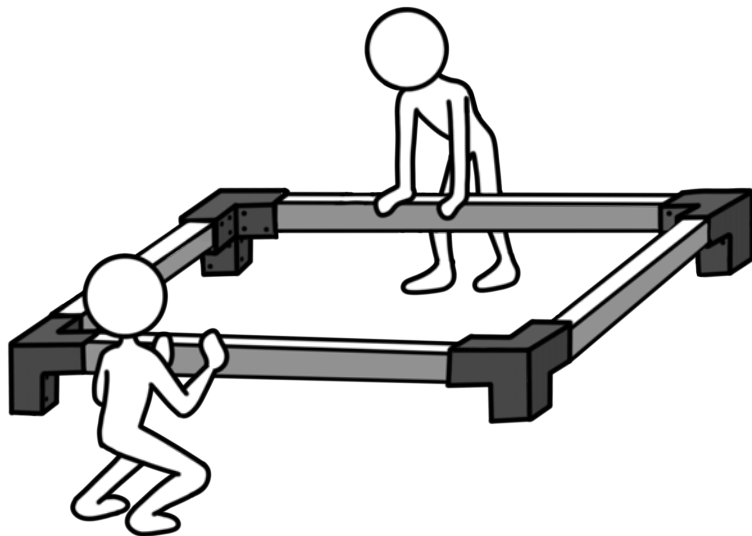
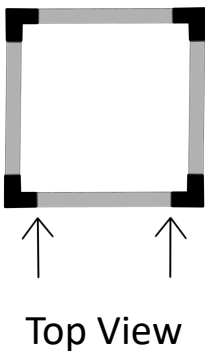

STEP 5 INSERT 2 SCREWS IN EACH CORNER

- Ensure parallel, opposite sides are equal length.
- Insert 2 screws into the outer single holes using an electric drill and the provided bit. Repeat on all 4 corners of the pergola.

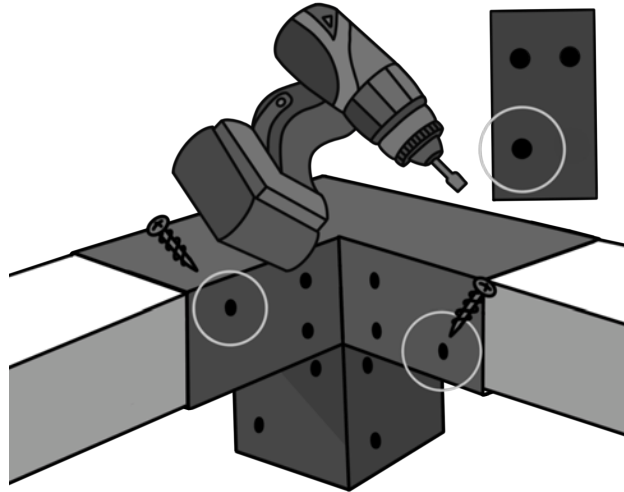

STEP 6 IF NOT INSTALLING SUNSHADE

- Insert all remaining interior corner screws and SKIP TO STEP 10

STEP 7 INSTALL 4 CORNER BRACKETS

- Attach bracket to upper pair of holes using screws.
- Insert screws into lower pair of holes. Repeat 4 corners.

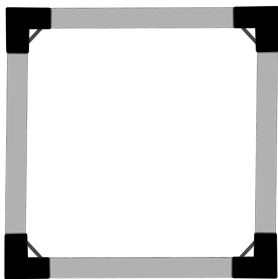

Top View

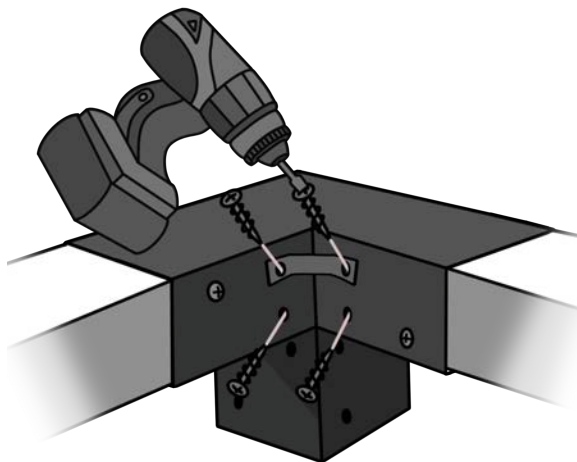

STEP 8 ATTACH SUNSHADE IN 4 CORNERS

- Loop strap through each bracket and snap buckle together.
- Repeat on all 4 corners. Cinch tight.

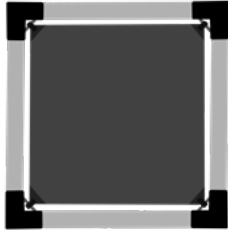

Top View

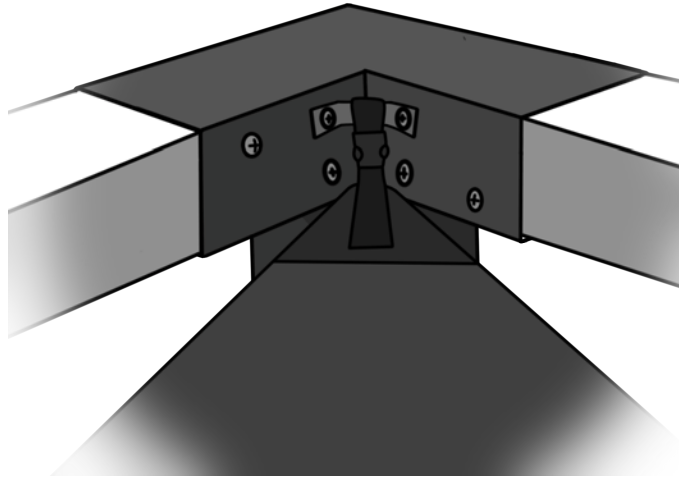

STEP 9 ATTACH SIDE BRACKETS AND STRAPS

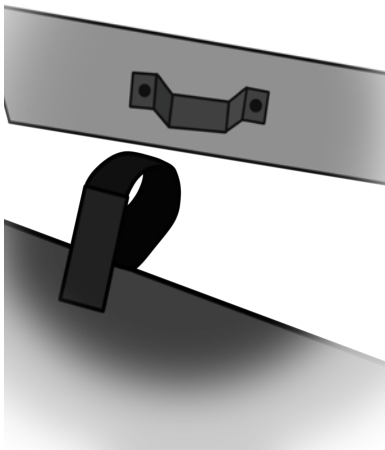

Pull side strap to post, mark bracket location.

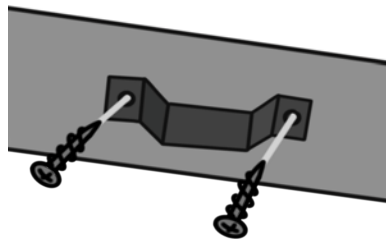

Attach bracket with screws.

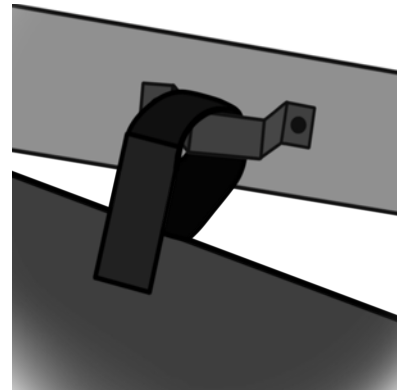

Loop strap and snap together buckle. Repeat on all.

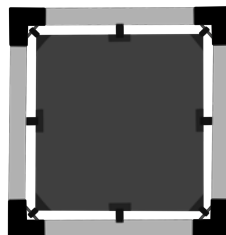

Top View

STEP 10 INSERT 2 UPRIGHT POSTS

- Have 2 adults tilt up one side of the pergola top, while a 3rd adult inserts posts.
- Don't attach screws.

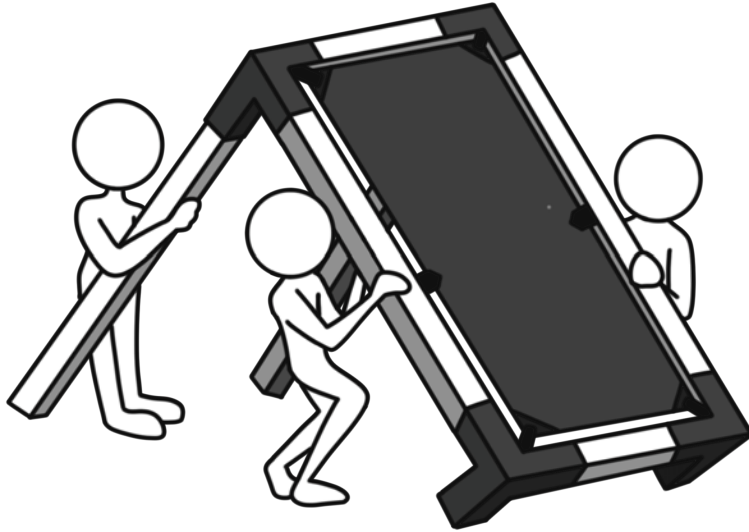

STEP 11 RAISE PERGOLA WITH 4 LEGS

- Have two adults on ladders lift the pergola top.
- Insert posts when angle permits.

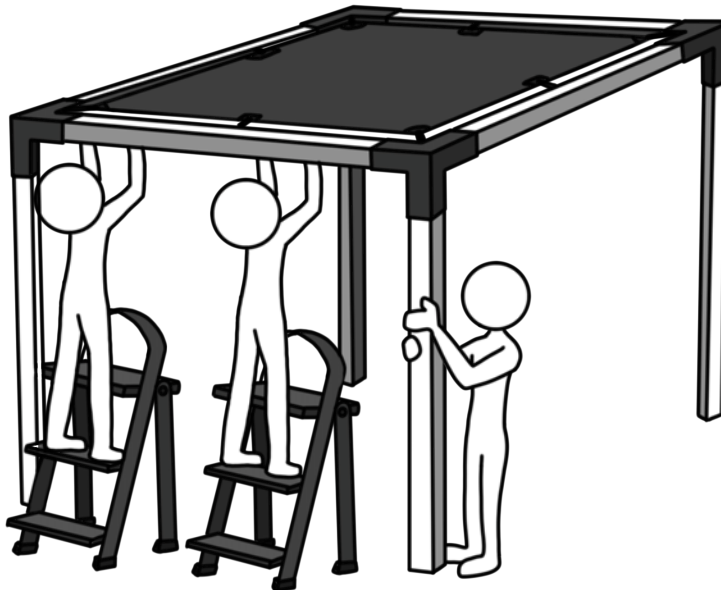

STEP 12 INSERT ALL TOP SCREWS

- Using a ladder to access the underside of the pergola top, insert screws in all empty holes, including both horizontal beam arms and upright posts. Repeat on all 4 posts.

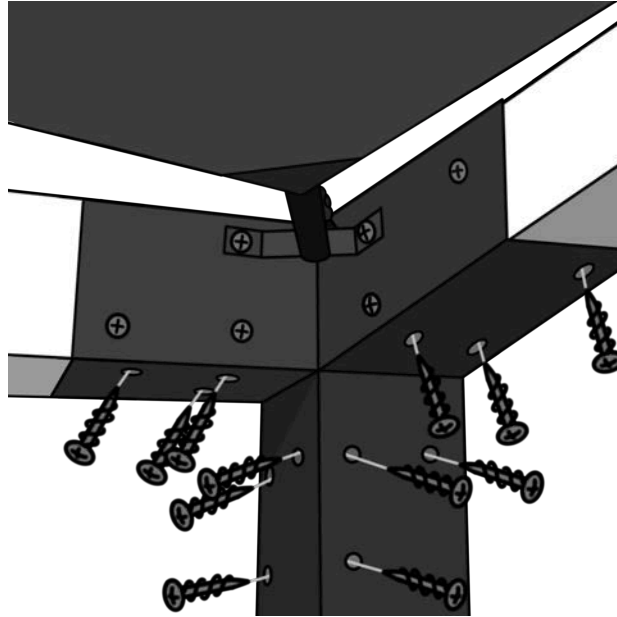

STEP 13 PUT UNIFIT ON EACH POST BOTTOM

- Have two adults lift each leg while one adult slides a Unifit under the post. Slowly drop post into Unifit.
- Attach screws.

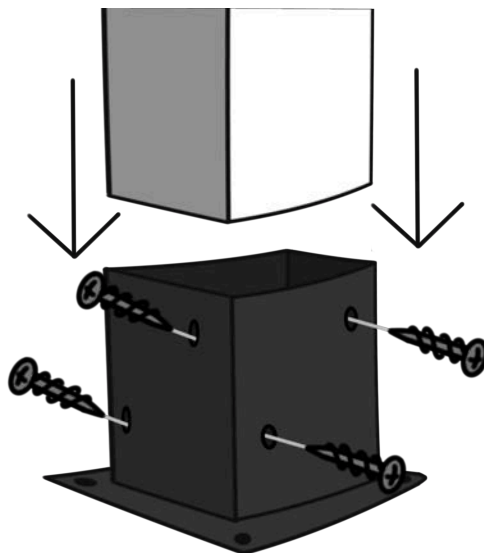

STEP 14 SQUARE AND LEVEL THE BASE

- Measure and align all posts.
- Plumb all upright posts

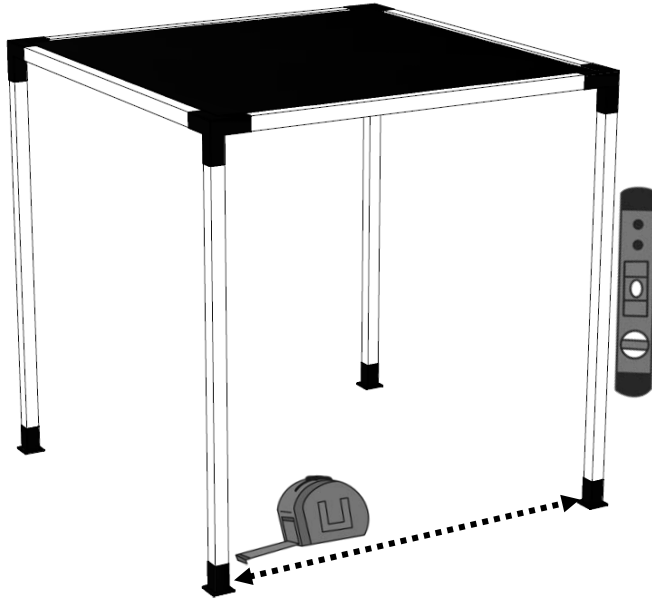

STEP 15 ATTACH UNIFIT POST BASES TO GROUND

- Affix post base to substrate per local building codes.
- FASTENERS NOT INCLUDED FOR ANCHORING

