

Revised VertiCable Series

(Style C80)

Installation Instructions



- These instructions must be followed exactly as written and the materials used must be exactly as shown in the instructions. Any deviation from the instructions or variation in the materials used/installed may result in an unsuccessful installation.
- When core drilling any post product where water can build up, the installer is responsible to drill a 1/4" hole as close to the bottom of the post by concrete as possible. If there is no weep hole, you may have damage from moisture build up and freezing thus potentially voiding the powder coating warranty.

Installing Alum. Post w/ Adjustable Plate

NOTE: The installer is responsible to have the substructure strong enough to support the post for what it is rated

1. Place the (2) stainless steel strips below the plate under the leveling bolts.
2. **a. For general installation:** fasten aluminum post to wood surface using (4) 3/8" x 5" or longer stainless steel lags (lags not included). **WARNING: When installing the Aluminum Post on top of a wood structure, the 5" lags MUST be lagged into at least 4" of solid wood! It will not be strong enough if it is fastened into a 5/4" or a 1 1/2" thick deck board!** Below is an example of how to design the wood structure to accept the Aluminum Post. Any other way must meet or exceed these qualifications.

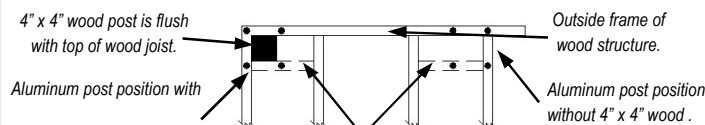

Add extra 2" x 6" blocking (if 4" x 4" wood post exists, attach to 4" x 4" post). Position aluminum mount over posts. All 4 lags will fasten to a joist or 2" x 6" board.

2. **b. For IRC wood surface installation:** attach wood blocking to substructure with #10 x 3" wood screws. Fasten aluminum post using (4) 3/8" x 5-1/2" bolts (anchors not included) thru aluminum backer plate (sold separately) as shown below.

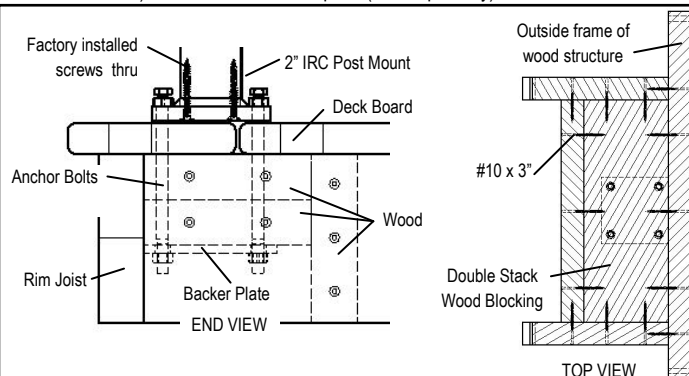

2. **c. For concrete installation**, fasten aluminum post to concrete using (4) 3/8" x 3" or longer concrete anchors (anchors not included.)

3. Use a 1/2" open end wrench to level aluminum post with the leveling bolts on the welded plate.
4. Attach caps. Lightly tap with rubber mallet if needed.

Angle (Swivel) Mount

1. **a.** Position bottom swivel mount base so the bottom of the rail has no more than a 2" clearance. **NOTE: A 1 1/8" spacer may be placed on the welded 3/8" plate of the post to reach the 2" clearance. 1 1/4" spacer for 1/2" plate.**
b. Measure up 32 5/8" (for 36" tall railing) or 38 5/8" (for 42" tall railing) from top of bottom mount to top of top mount.
2. Keeping base of mount centered and pin hole turned down, fasten base to post with pan head self-tapping screws (provided).
3. Angle the swivel mount after it is installed on post. Measure from back of cup at one end to back of cup at

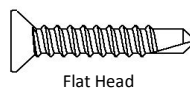
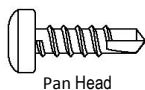

Angle (Swivel) Mount Cont'd

other end to determine rail length. Cut rails.

4. Install sections as specified in Standard (Level) railing steps 4-7.

Standard (Level) Railing

Note: Top rail is 1" longer on each end to accommodate Crossover railing.

1. Cut the rails to length by holding rails against posts. Position so there will be the same baluster or cable spacing on each end of rails (**if possible**). Minimum spacing between post and cable is 1-5/8". Mark rails where they are to be cut. **Make sure rail is cut 1/4" shorter on each end to allow for mounts.** Cut rails.

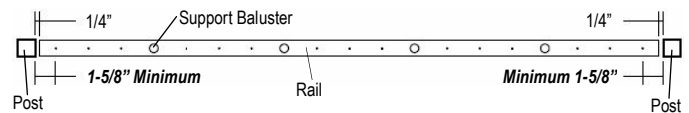

Crossover railing- Cut bottom rail same as above. For top rail, make end spacing exactly 1" longer on all ends connecting to the crossover post.

2. Attach bottom wall mount to post by positioning the bottom rail so there is no

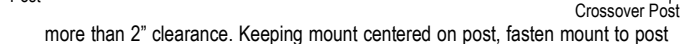

more than 2" clearance. Keeping mount centered on post, fasten mount to post with pan head self-tapping screws (provided). A 1-3/8" spacer may be placed on the welded 3/8" plate of the post to reach the 2" clearance. Use a 1-1/4" spacer for posts with 1/2" plate.

3. Attach top wall mount to post by measuring up 32-5/8" (for 36" tall railing) or 38-5/8" (for 42" tall railing) from the top of the bottom mount to the top of the top mount. Keeping mount centered on post, fasten mount to post with self-tapping pan head screws (provided).

4. Fasten rail support to bottom side of bottom rail by inserting pan head self-tapping screw (provided) through center of threaded portion of support. This applies to all sections over 6ft long.

5. Loosen cable(s) between end of rails and first support baluster on both ends of assembly by loosening hex nut(s) on underside of bottom rail.

6. Place rails into mounts. Fasten both rails through side of mounts with flat head self-tapping screws provided.

Crossover railing- Fasten top rail to crossover adaptor with pan head screws provided. **NOTE: If screw stops penetrating top rail, rotate screw in reverse several revolutions while maintaining penetration pressure to remove potential material burr from tip of screw. Then continue to install screw; repeat as necessary.**

7. Tension cable(s) between end of rails and first support baluster on both ends of assembly by tightening hex nut(s) on underside of bottom rail. Proper cable tension is 200 lbs. [90 kg] per cable. A cable tension gauge is recommended. **Do not overtighten.**

8. Snap covers on all mounts.

9. Attach 2 piece flair to all posts.

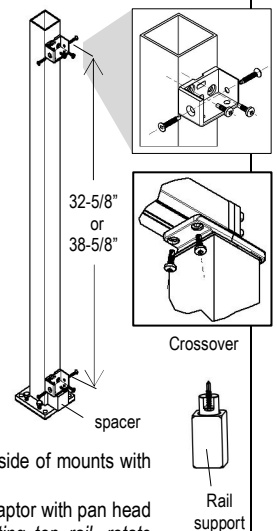

Revised VertiCable Series

(Style C80)

Installation Instructions



- These instructions must be followed exactly as written and the materials used must be exactly as shown in the instructions. Any deviation from the instructions or variation in the materials used/installed may result in an unsuccessful installation.
- When core drilling any post product where water can build up, the installer is responsible to drill a 1/4" hole as close to the bottom of the post by concrete as possible. If there is no weep hole, you may have damage from moisture build up and freezing thus potentially voiding the powder coating warranty.

Stair Railing

1. Lay bottom rail beside posts with approximately 1" clearance (use 1" spacer) between the rail and nose of step.
2. Position rails against posts and even the end spacing on each end, if possible, with balusters parallel to the post. Minimum 2" spacing between post and cable. (Example 1.) Clamp rails to post. Mark rails for cutting. Mark posts for each mount position (Example 2). Cut rails 3/16" shorter than mark on each end. (Example 3). If using 6" post attach one-piece flair now.

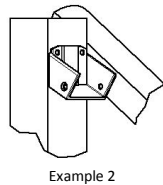
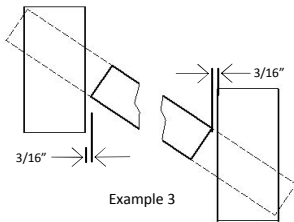
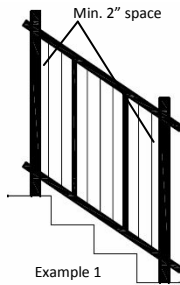

3. **Crossover Railing:** For crossover stairs set stair crossover kit next to rails that are fastened to post to determine what height to cut post. Mark post and cut. Make a small countersink in side of post with 3/8" bit so flair will fit over flat head screw. Set crossover connector in post and fasten at proper height with self-tapping flat head screws provided. Set correct angle for crossover connector to match railing. Cut bottom rails same as above in step 3 (Example 3). Mark top rails to cut making sure it fits snug into the crossover connector (Example 4).

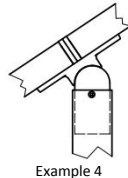

4. Attach mounts to post with pan head self-tapping screws (provided).

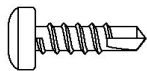

Pan Head



Flat Head

5. Place stair section into mounts.
6. Attach rails to mounts by inserting flat head self-tapping screws (provided) through both sides of mounts. Lightly tap mount covers onto mounts. (Use caution when installing covers by applying pressure directly on top of the cover tab.)
7. Tension all cables of assembly by tightening hex nuts on underside of bottom rail with 3/4" socket. Proper cable tension is 200 lbs. [90 kg] per cable. A cable tension gauge is recommended. **Do not overtighten.**
8. Attach 2-piece flairs to all posts.

Stair Swivel Mount

1. Identify top swivel mount and bottom swivel mount.

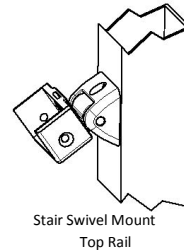

Stair Swivel Mount
Top Rail

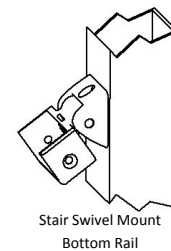

Stair Swivel Mount
Bottom Rail

2. Lay bottom rail (with approximately 1" clearance from the nose of the steps) beside the posts. Position rails against posts and even the end spacing on each end, if possible, with balusters parallel to the post. Minimum 3" spacing between post and cable. (Example 5.) Clamp rails to post. Hold swivel stair mounts up against posts and beside the rail to determine where rails are to be cut to fit inside the swivel stair mounts. Mark posts for each stair swivel mount position (Example 6). **NOTE: This will vary depending on angle of stairs.** Cut rails. Cut top rail at same length as bottom rail unless using crossover application.

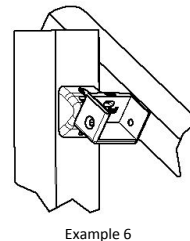
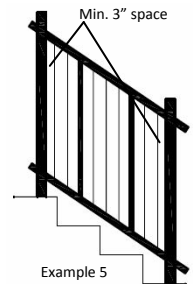

Example 6

3. Attach bottom swivel mount base so the bottom rail has approximately 1" clearance from the nose of the step. (NOTE: A 1" spacer may be placed on the nose of the step to reach the 1" clearance.) Fasten base to post with pan head self-tapping screws (provided).
4. Attach top swivel mount base to post using pan head self-tapping screws (provided).
5. Attach rails to mounts using flat head self-tapping screws (provided) on each side of rail.
6. Tension all cables of assembly by tightening hex nuts on underside of bottom rail with 3/4" socket. Proper cable tension is 200 lbs. [90 kg] per cable. A cable tension gauge is recommended. **Do not overtighten.**
7. Attach 2 piece flair to all posts.

Video Installation Instructions
on YouTube

